

HAM-LET INDUSTRIAL MECHANICAL

PRESSURE GAUGES



HAM-LET INDUSTRIAL MECHANICAL PRESSURE GAUGES

INDEX

Selection Guide	3
Industrial Mechanical Pressure Gauges	4
Ordering Information	27
Dial Range Ordering Codes	28
Options Ordering Codes	29
Accessories	30



IMPH
series
Heavy Duty
Page 7



IMPG
series
General Use
Page 11



IMPS
series
Safety Pattern/Solid
Front Page 15



IMPP
series
Process Gauge
Page 19



IMPL
series
Low Pressure
Page 23

HAM-LET Pressure Gauges Process Connections



BSP-P Thread



NPT Thread



HAM-LET
Tube adapter



HAM-LET Face Seal
Male swivel



HAM-LET Face Seal
Female swivel

HAM-LET PRESSURE GAUGES SELECTION GUIDE

Series	Type	Configuration			Liquid Fillable	Solid Front	Safety Glass Window	Adjustable Pointer	Accuracy	Case Size	Measurement Range
		C	B	L						mm (inch)	
Heavy Duty	H	Yes	Yes	Yes	Yes	-	Yes	Yes	1.6% ± EN 837 Class 1.6 (Class 2.5 for 0-600 & 0-1000 bar range)	63 (2.5)	Vacuum: -1 - 0 bar Pressure: 0 - 1000 bar
		-	Yes	Yes	Yes	-	Yes	Yes	1.0% ± EN 837 Class 1.0	100 (4)	
		-	Yes	Yes	Yes	-	Yes	Yes		160 (6)	
General Use	G	Yes	-	Yes	Yes	-	Yes	-	± 1.6% EN 837 Class 1.6 (Class 2.5 for 0- & 0-1000 bar range)	40 (1.5)	Vacuum: -1 - 0 bar Pressure: 0 - 600 bar
		Yes	-	Yes	Yes	-	-	-		50 (2)	
		Yes	Yes	Yes	Yes	-	Yes	-		63 (2.5)	Vacuum: -1 - 0 bar Pressure: 0 - 1000 bar
		-	Yes	Yes	Yes	-	Yes	-	± 1.0% EN 837 Class 1.0	100 (4)	
		-	Yes	Yes	Yes	-	Yes	-	± 1.0% EN 837 Class 1.0	160 (6)	
Safety Pattern / Solid Front	S	-	Yes	Yes	Yes	Yes	Yes	Yes	± 1.6% EN 837 Class 1.6 (Class 2.5 for 0-600 & 0-1000 bar range)	63 (2.5)	Vacuum: -1 - 0 bar Pressure: 0 - 1000 bar
		-	Yes	Yes	Yes	Yes	Yes	Yes	± 1.0% EN 837 Class 1.0	100 (4)	
		-	-	Yes	Yes	Yes	Yes	Yes		160 (6)	
Process	P	-	-	Yes	Yes	Yes	Yes	Yes	± 0.5% ASME B40.1 Grade 2A	115 (4.5)	Vacuum: -1 - 0 bar Pressure: 0 - 1000 bar
Low Pressure	L	Yes	-	Yes	Yes	-	Yes	-	± 1.6% EN 837 Class 1.6	63 (2.5)	Vacuum: -25 - 0 mbar Pressure: 0 - 600 mbar
		Yes	-	Yes	Yes	-	Yes	Yes		100 (4)	

INDUSTRIAL MECHANICAL PRESSURE GAUGES:

Bourdon Tube Measuring Element

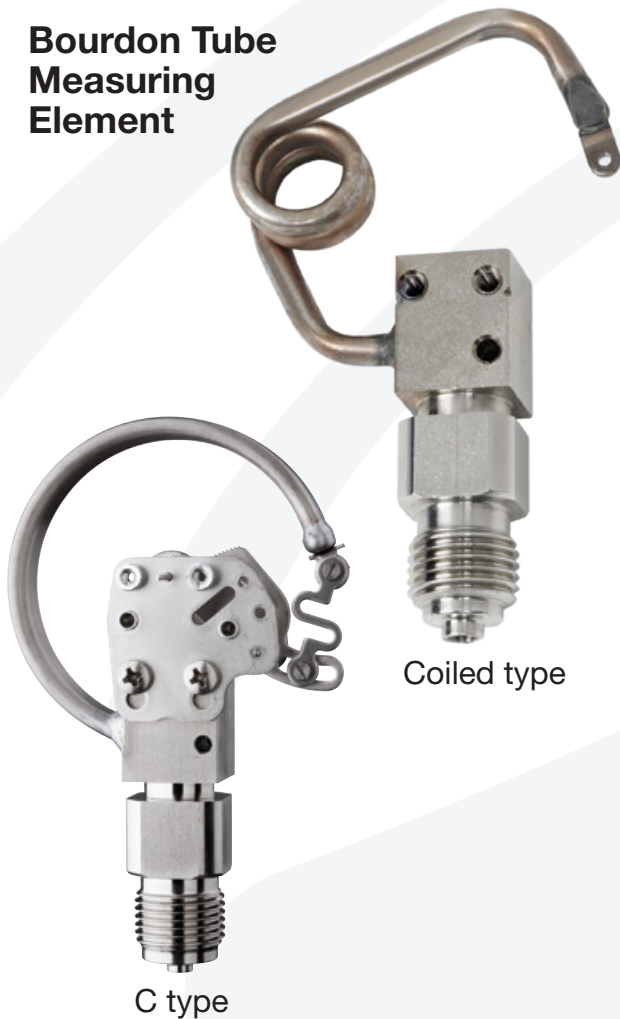

Coiled type

C type

General:

The Industrial Mechanical Pressure gauges are measuring devices constructed from only high quality materials, by the highest quality standards and methods.

The IMP gauge guarantee long life with durability for in-door and out-door industrial, process and instrumentation applications.

💡 The IMP product variety in the catalog covers standard gauges, extensive options are available

Features:

- Nominal case sizes: 40, 50, 63, 100, 115, 160 mm (1½", 2", 2½", 4", 4½", 6").
- Pressure, Vacuum and Compound measuring ranges.
- Pressure ranges of
0-1 inH₂O up to 0-250 inH₂O (0-2.5 mbar up to 0-600 mbar),
0-10 up to 0-15,000 psi (0-0.6 up to 0-1000 bar) and above.
- Accuracy of ± 0.5/1/1.6/2.5 % of span (EN 837-1 Class 1/1.6/2.5, ASME B40.1 Grade 1A/2A /B/C).
- Manufactured in accordance to EN 837 and ASME B40.1 standards.
- All wetted parts made of 316L Stainless Steel (Alloy 400 as an option).
- Connections include threaded, tube adapter and face seal.

HAM-LET INDUSTRIAL MECHANICAL PRESSURE GAUGES

Cleaning:

- Special cleaning of wetted parts is available upon request –
- Lubricants free.
 - Silicon free.
 - Cleaned for Oxygen service.

Testing & Calibration:

All IMP gauges are factory calibrated and bubble tested for leakage.
Helium leak test is available.

Selecting Pressure Gauge For Your Application

Selecting the proper gauge to withstand application pressures, temperature, media's chemical effects and environmental conditions is a prime concern for the system engineer. The EN 837-2 or ASME B40.1 standard should be considered as a guideline for proper selection.
For assistance in matching the proper pressure gauge for your application, please consult a HAM-LET local representative.

Filling:

Gauge cases are often liquid filled to protect the internals against damages caused by severe vibrations or pressure pulsations and exclude condensation in outdoor installations.

All IMP gauges can be filled or unfilled as ordered, the gauges are always fillable.

- Standard filling is Glycerin (99%) .
- Glycerin (86%) for low ambient temperatures, Silicon oil, other filling as an option.

Warning!

Glycerin and Silicon oil must be avoided where Oxygen or other strong oxidizing agents are present.

Scale Selection And Load Limits:

General recommendation for working measured pressure is to be in the range of 25-65% for pulsating pressures and 25-75% for steady pressures out of the maximal dial range.

Recommended working pressure range

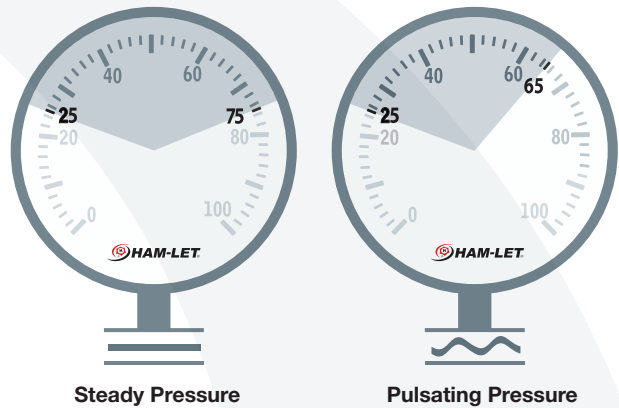

Maximal pressure load limits for operation without loss of accuracy:

Case size: 100, 115, 160 mm (4", 4½", 6")	
Type of load	Pressure load limit out of full scale
Steady	100%
Pulsating (cyclic)	90%
Overpressure (temporary)	130%

Case size: 40, 50, 63 mm (1½", 2", 2½")	
Type of load	Pressure load limit out of full scale
Steady	75%
Pulsating (cyclic)	65%
Over pressure (temporary)	100%

- 💡 The IMP gauges are constructed to withstand up to 300% full scale temporary over pressure without system failure.
- 💡 With low pressure gauges (L series), up to 1000% full scale over pressure protection can be supplied as an option.

HAM-LET INDUSTRIAL MECHANICAL PRESSURE GAUGES

Process Connections:

Stainless steel process connections maximal pressure

Connection		Maximal Pressure
Type	Size	
BSP-P	1/8"	6,000 psi (400 bar)
NPT		
BSP-P	1/4"	15,000psi (1000 bar)
NPT		
FACE SEAL	1/4"	5,200psi (359 bar)
NPT	1/2"	15,000psi (1000 bar)
BSP-P	1/2"	20,000psi (1600 bar)
HP		
Tube Adapter	1/4", 6mm	10,000psi (600 bar)
	3/8", 1/2", 10mm, 12mm	6,000 psi (400 bar)

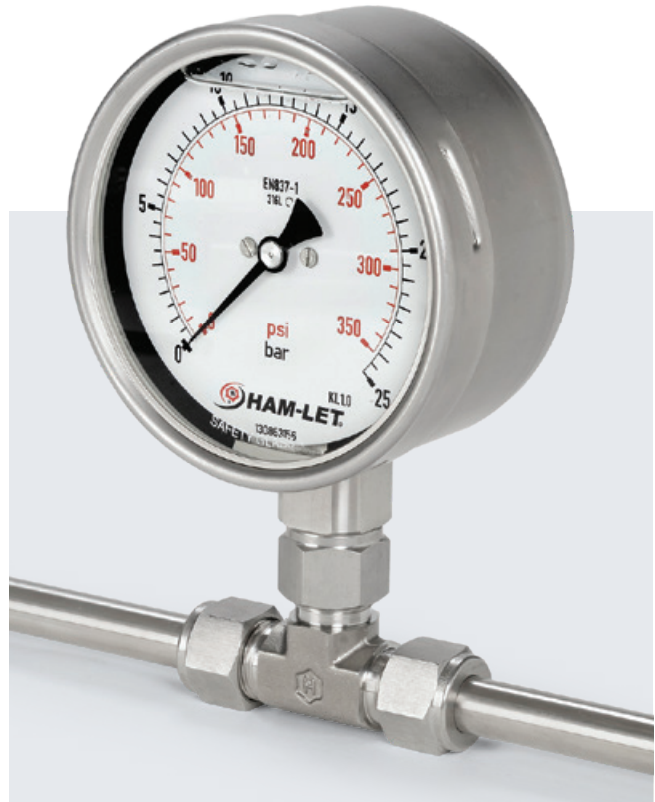

Temperature limitations

Temperature Limitations	Unfilled	Glycerin (99%) Filled	Glycerin (86%) Low Temperature Filled
Storage	-40 to +158 °F	-4 to +158 °F	-4 to +158 °F
	(-40 to +70 °C)	(-20 to +70 °C)	(-20 to +70 °C)
Ambient	-40 to +140 °F	-4 to +140 °F	-40 to +140 ° F
	(-40 to +60 °C)	(-20 to +60 °C)	(-40 to +60 °C)
Media Max. H,G,S Series	+392 °F	+212 °F	+212 °F
	(+200 °C)	(+100 °C)	(+100 °C)
Media Max. P,L Series	+212 °F	+158 °F	+158 °F
	(+100 °C)	(+70 °C)	(+70 °C)

Reference Temperature:

The measuring device is calibrated for working temperature of +68°F (+20°C).

A 0.4% deviation in the measured pressure for each +18 °F (+10 °C) temperature change should be expected.



For extreme ambient or media temperatures, please consult a HAM-LET local representative.

Warning!

The system designer and user have the sole responsibility for selecting products suitable for their special application requirements, ensuring their safe and trouble-free installation, operation, and maintenance. Application details, material compatibility and product ratings should all be considered for each selected product. Improper selection, installation or use of products can cause property damage or personal injury.



**HEAVY DUTY
PRESSURE GAUGES**

IMPH
SERIES



IMPH series

Data Sheet:

General:

The industrial mechanical, H-Heavy duty pressure gauges series is designed to be used in industrial, instrumentation and process applications that require long durability with accuracy and easy maintainability for indoor, outdoor and harsh environments. The H series pressure gauges are bourdon tube mechanical devices. Case sizes 63, 100, 160mm (2½", 4", 6") are suitable for vacuum to pressure up to 1000 bar (15,000 psi).

Features:

- All stainless steel case and wetted parts.
- Bayonet ring and adjustable pointer for easy adjustment.
- Safety laminated glass front.
- Case is filled or fillable dry.
- Case protection: IP 65 (IP 54 for 160mm (6") case with range 30psi (2.5bar) and below).
- Safety category (EN 837-1) S1 for pressure gauges with blow-out device 100mm (4") and 63mm (2½") cases.
- Measuring Ranges
 - Vacuum: 30" Hg Vac. to 0 psi (-1 to 0 bar)
 - Compound: 30" Hg Vac. through 0 to 300 psi (-1 through 0 to 15 bar)
 - Pressure: 0 to 15,000 psi (0 to 1,000 bar), 40mm (1½") case up to 10,000 psi (600 bar)

Materials Of Construction

Part		Material
Wetted Parts	Process connection	SS 316L
	Bourdon Tube	
Case		SS 304
Window		Laminated safety glass
Movement		Stainless steel
Dial		Aluminum (black figures, white background)
Pointer		Aluminum (black)

HAM-LET INDUSTRIAL MECHANICAL PRESSURE GAUGES



Technical data

Case Size		63mm (2½")	100mm (4")	160mm (6")
Accuracy	Up to 6,000psi (400 bar)	±1.6% of span EN 837-1 Class 1.6 ASME B40.1 Grade B	±1.0% of span EN 837-1 Class 1.0 ASME B40.1 Grade 1A	±1.0% of span EN 837-1 Class 1.0 ASME B40.1 Grade 1A
	10,000psi (600 bar) and above (2)	±2.5% of span EN 837-1 Class 2.5 ASME B40.1 Grade C	±1.0% of span EN 837-1 Class 1.0 ASME B40.1 Grade 1A	±1.0% of span EN 837-1 Class 1.0 ASME B40.1 Grade 1A
Case Configurations	Process connection position			
	Mounting device (Optional)			
Process Connection	½", 12mm Tube adapter		+	
	3/8", 10mm Tube adapter	+		
	¼", 6mm Tube adapter	+		
	½" BSP-P/NPT		+	+
	¼" BSP-P/NPT	+	+	+
	1/8" BSP-P/NPT	+		
	M20x1.5		+	+
	M12x1.5	+	+	+
Blow-Out Device	Blow-out device at the top of the case			+
	Blow-out plug in the back of the case, Ø 40mm (1½")		+	
	Blow-out plug at the top of the case	+		
Case Ventilation	By blow-out device / Plug	+		+
	Internal pressure compensation by pressure equalizing membrane		+	
Weight (1) Pound (Kg.)	Unfilled	0.40 (0.18)	1.33 (0.60)	2.43 (1.10)
	Filled	0.55 (0.25)	2.10 (0.95)	4.30 (1.95)

(1) Approx. without mounting device

(2) See Maximal pressure per connection type, page 3

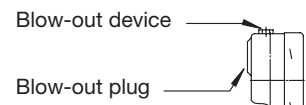



Configuration And Mounting Dimensions

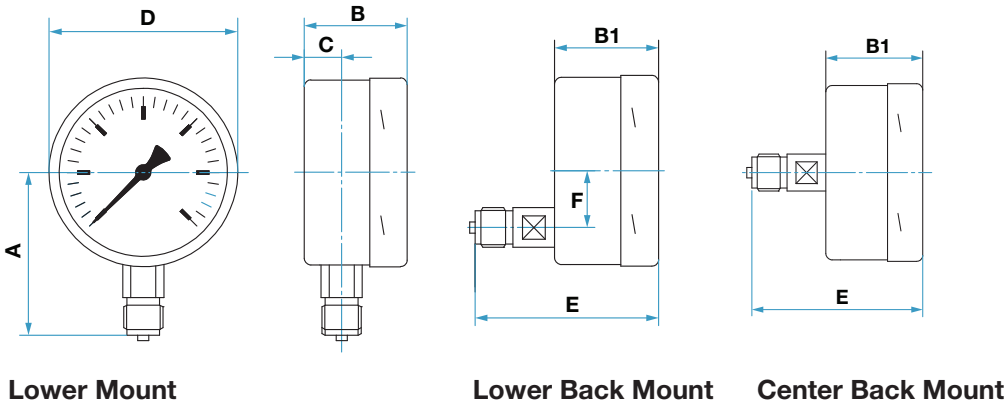

Lower Mount

Lower Back Mount

Center Back Mount

Case Size		A		B		B1		C		D		E		F	
mm	inch	mm	inch	mm	inch	mm	inch	mm	inch	mm	inch	mm	inch	mm	inch
63	2 1/2	54	2.13	33	1.3	37	1.46	10	0.39	64	2.52	59	2.32	18	0.71
100	4	87	3.43	55	2.17	55	2.17	20	0.79	101	3.98	97	3.82	30	1.18
160	6	115	4.53	51	2.01	51	2.01	15.5	0.61	161	6.34	92.5	3.64	30	1.18

Back Flange Mounting

Front Flange Mounting

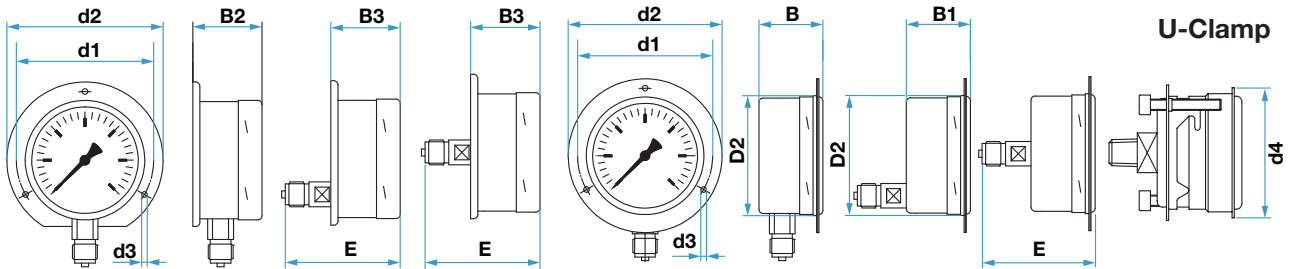

Case Size		B2		B3		D2		d1		d2		d3		d4	
mm	inch	mm	inch	mm	inch	mm	inch	mm	inch	mm	inch	mm	inch	mm	inch
63	2/1 2	36	1.42	40	1.57	66	2.6	75	2.95	85	3.35	3.6	0.14	-	-
100	4	58.5	2.3	58.5	2.3	103	4.06	116	4.57	132	5.2	4.8	0.19	-	-
160	6	54	2.13	54	2.13	163	6.42	178	7.01	196	7.72	5.8	0.23	-	-



**GENERAL USE
PRESSURE GAUGES**

IMP**G**
SERIES

**G**

IMP**G** series

Data Sheet:

General:

The Industrial, G – General Use pressure gauges series guarantee long life and durability for indoor, outdoor and harsh surroundings, industrial, instrumentation and process applications.

The G series pressure gauge is a bourdon tube mechanical device, Case sizes 50, 63, 100, 160mm (2", 2½", 4", 6") suitable for vacuum to pressure up to 1000 bar (15,000 psi).

Features:

- All stainless steel case and wetted parts.
- Polished Crimped-on ring for firm window sealing.
- Safety laminated glass front.
- Case is filled or fillable dry.
- Case protection: IP 65 (IP 54 for 160mm (6") case with range 30psi (2.5bar) and below).
- Safety category (EN 837-1) S1 for pressure gauges with blow-out device.
- Measuring Ranges
 - Vacuum: 30" Hg Vac. to 0 psi (-1 to 0 bar)
 - Compound: 30" Hg Vac. through 0 to 300 psi (-1 through 0 to 15 bar)
 - Pressure: 0 to 15,000 psi (0 to 1,000 bar), 50mm (2") case up to 10,000 psi (600 bar)

Materials Of Construction

Part		Material
Wetted Parts	Process connection	SS 316L
	Bourdon Tube	
Case		SS 304
Window		Laminated safety glass
Movement		Stainless steel
Dial		Aluminum (black figures, white background)
Pointer		Aluminum (black)



Technical data

Case Size		40mm (1½") 50mm (2")	63mm (2½")	100mm (4")	160mm (6")	
Accuracy	Up to 6,000psi (400 bar)	±1.6% of span EN 837-1 Class 1.6 ASME B40.1 Grade B	±1.6% of span EN 837-1 Class 1.6 ASME B40.1 Grade B	±1.0% of span EN 837-1 Class 1.0 ASME B40.1 Grade 1A	±1.0% of span EN 837-1 Class 1.0 ASME B40.1 Grade 1A	
	10,000 psi (600 bar) and above (2)	±2.5% of span EN 837-1 Class 2.5 ASME B40.1 Grade C	±2.5% of span EN 837-1 Class 2.5 ASME B40.1 Grade C	±1.0% of span EN 837-1 Class 1.0 ASME B40.1 Grade 1A	±1.0% of span EN 837-1 Class 1.0 ASME B40.1 Grade 1A	
Case Configurations	Process connection position					
	Mounting device (Optional)					
Process Connection	½", 12mm Tube adapter			+		
	3/8", 10mm Tube adapter		+	+		
	¼", 6mm Tube adapter		+	+		
	½" BSP-P/NPT			+	+	
	¼" BSP-P/NPT	+(4)	+	+	+	
	1/8" BSP-P/NPT	+	+	+		
	M20x1.5			+	+	
	M12x1.5	+(4)	+	+	+	
¼" face seal Male/Female swivel	+(5)	+	+(3)			
Blow-Out Device	Blow-out device at the top of the case				+	
	Blow-out plug in the back of the case, Ø 40mm (1½")			+		
	Blow-out plug at the top of the case			+		
Case Ventilation	By blow-out device / Plug		+	+	+	
	Internal pressure compensation by pressure equalizing membrane	+(6)			+	
Weight (1) Pound (Kg.)	Unfilled	0.15 (0.07)	0.198 (0.09)	0.40 (0.18)	1.33 (0.60)	2.43 (1.10)
	Filled	0.22 (0.10)	0.286 (0.13)	0.55 (0.25)	1.98 (0.90)	3.75 (1.70)

- (1) Approx. without mounting device
- (2) See Maximal pressure per connection type, page 3
- (3) female face seal only in "B" lower back mount
- (4) Center back only
- (5) Up to 100 bar
- (6) For pressure ranges up to 0-200psi (0-16 bar)

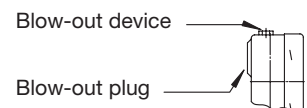



Configuration And Mounting Dimensions

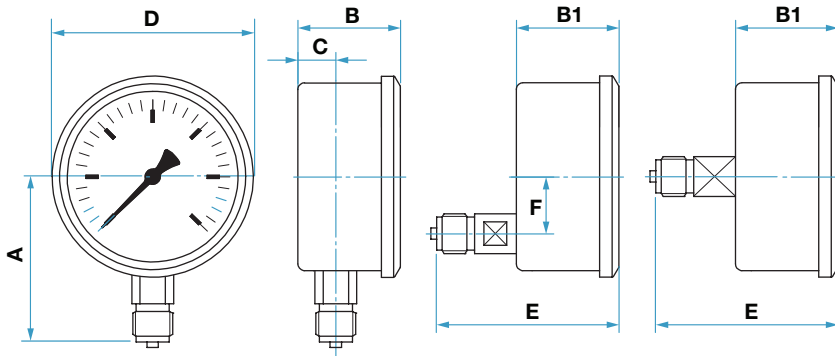

Lower Mount

Lower Back Mount

Center Back Mount

Case Size		A		B		B1		C		D		E		F	
mm	inch	mm	inch	mm	inch	mm	inch	mm	inch	mm	inch	mm	inch	mm	inch
40	1 1/2	34.5	1.36	28	1.1	30	1.18	10	0.4	40	1.57	47	1.85	-	-
50	2	45	1.77	29	1.14	31	1.22	10	0.4	54	2.13	50	1.97	-	-
63	2 1/2	54	2.13	33	1.3	37	1.46	10	0.40	67	2.63	60	2.36	18	0.71
100	4	87	3.43	54	2.13	54	2.13	20	0.79	106	4.17	96	3.78	30	1.18
160	6	115	4.53	50	1.97	55	2.17	15	0.59	167	6.57	97	3.82	30	1.18

Back Flange Mounting

Front Flange Mounting

U-Clamp

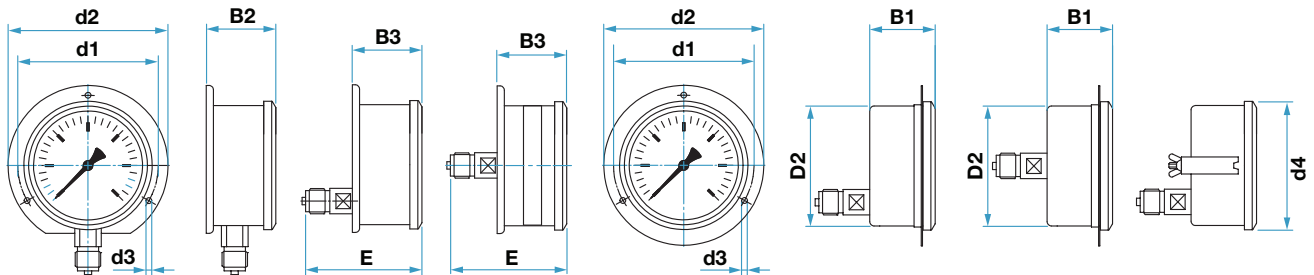

Case Size		B2		B3		D2		d1		d2		d3		d4	
mm	inch	mm	inch	mm	inch	mm	inch	mm	inch	mm	inch	mm	inch	mm	inch
40	2/1 1	-	-	-	-	41.8	1.64	51	2.01	61	2.4	3.6	0.14	46	1.81
50	2	-	-	-	-	51	2.01	60	2.36	71	2.8	3.6	0.14	71	2.8
63	2/1 2	36	1.42	40	1.57	64	2.52	75	2.95	85	3.35	3.6	0.14	-	-
100	4	57.5	2.26	57.5	2.26	101	3.98	116	4.57	132	5.2	4.8	0.19	-	-
160	6	53	2.09	58	2.28	-	-	178	7.01	196	7.72	5.8	0.23	-	-



**SAFETY PATTERN/SOLID FRONT
PRESSURE GAUGES**

IMPS
SERIES



IMPS series data sheet:

General:

The Industrial, S–Safety Pattern / Solid Front pressure gauges series is a heavy duty pressure gauge with a special case and a laminated safety glass window delivering a safer usage for the end system user while maintaining the long usability and durability for indoor, outdoor and harsh surroundings, industrial, instrumentation and process applications.

The safety pattern / Solid Front case has a break-proof solid front (a firm partition between the pressure element and the window) and a pressure relief back (blow-out back).

The S series gauges are marked with the © symbol on the dial. The S series pressure gauge is a bourdon tube mechanical device, case sizes 63, 100, 160mm (2½", 4", 6") suitable for vacuum to pressure up to 1000 bar (15,000 psi).

Features:

- All stainless steel case and wetted parts.
- Bayonet ring and adjustable pointer for easy adjustment
- Break-proof solid front case with blow-out back.
- Safety laminated glass front.
- Case is filled or fillable dry.
- Case Protection: IP 65.
- Safety Category (EN 837-1) S3.
- Measuring Ranges
 - Vacuum: 30" Hg Vac. to 0 psi (-1 to 0 bar)
 - Compound: 30" Hg Vac. through 0 to 300 psi (-1 through 0 to 15 bar)
 - Pressure: 0 to 15,000 psi (0 to 1,000 bar)

Materials of Construction



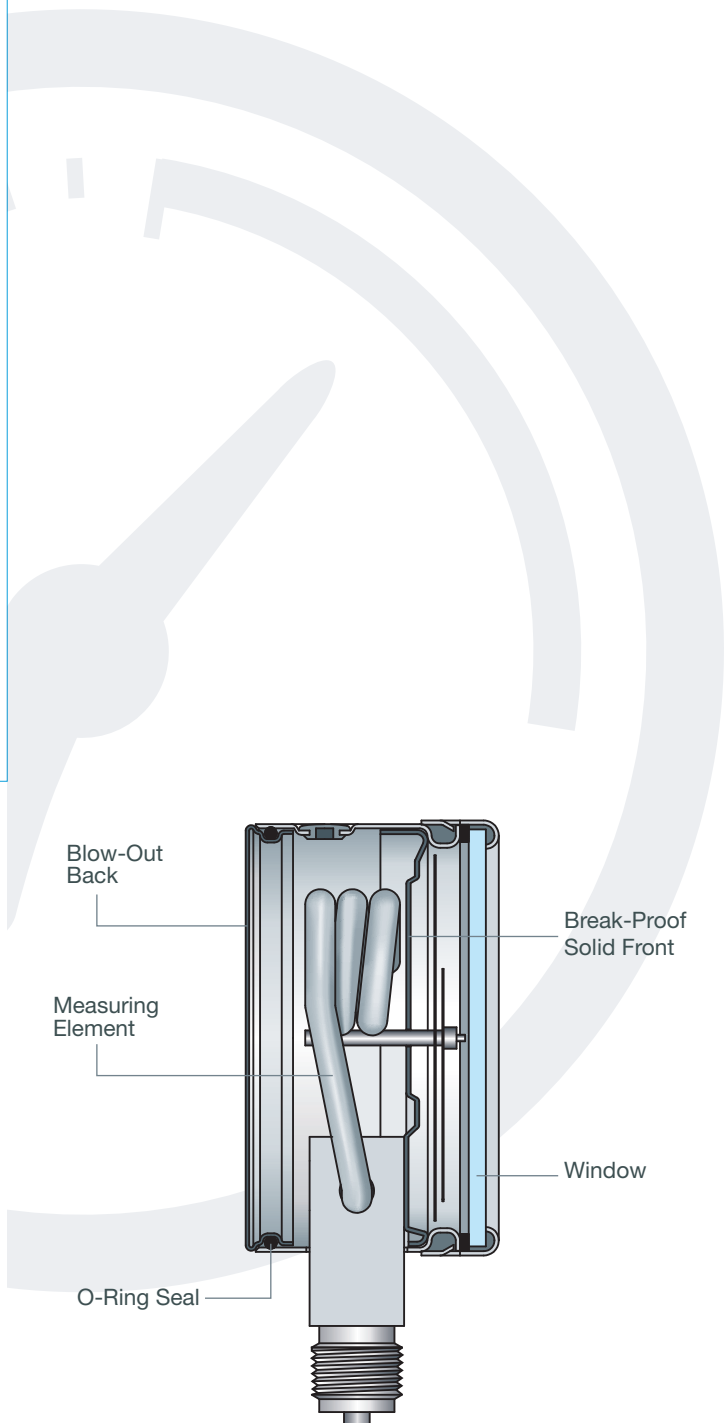



Part		Material
Wetted Parts	Process connection	SS 316L
	Bourdon Tube	
Case		SS 304
Window		Laminated safety glass
Movement		Stainless steel
Dial		Aluminum (black figures, white background)
Pointer		Aluminum (black)



PRESSURE GAUGES



Technical Data S Series

Case Size		63mm (2½")	100mm (4")	160mm (6")
Accuracy	Up to 6,000 psi (400 bar)	±1.6% of span EN 837-1 Class 1.6 ASME B40.1 Grade B	±1.0% of span EN 837-1 Class 1.0 ASME B40.1 Grade 1A	±1.0% of span EN 837-1 Class 1.0 ASME B40.1 Grade 1A
	10,000 psi (600 bar) and above (2)	±2.5% of span EN 837-1 Class 2.5 ASME B40.1 Grade c	±1.0% of span EN 837-1 Class 1.0 ASME B40.1 Grade 1A	±1.0% of span EN 837-1 Class 1.0 ASME B40.1 Grade 1A
Case Configurations	Process connection position			
	Mounting device (Optional)			
Process Connection	½", 12mm Tube adapter		+	
	3/8", 10mm Tube adapter	+	+	
	¼", 6mm Tube adapter	+	+	
	½" BSP-P/NPT		+	+
	¼" BSP-P/NPT	+	+	+
	1/8" BSP-P/NPT	+		
	M20x1.5		+	+
M12x1.5	+	+	+	
Blow-Out Device	Blow-out back	+	+	+
Case Ventilation	Screw with ventilation bore	+	+	+
	Internal pressure compensation by pressure equalizing membrane	+	+	
Weight (1) Pound (Kg.)	Unfilled	0.39 (0.18)	1.40 (0.65)	3.30 (1.50)
	Filled	0.55 (0.25)	2.20 (1.00)	6.5 (2.95)

(1) Approx. without mounting device

(2) See Maximal pressure per connection type, page 3

(3) Lower back connection available only for dry option

Configuration And Mounting Dimensions

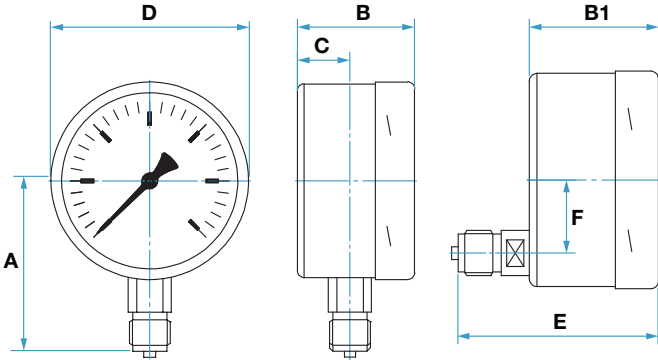

Lower Mount

Lower Back Mount

Case Size		A		B		B1		C		D		E		F	
mm	inch	mm	inch	mm	inch	mm	inch	mm	inch	mm	inch	mm	inch	mm	inch
63	2 1/2	54	2.13	41	1.61	41	1.61	18	0.71	64	2.52	63	2.48	18	0.71
100	4	87	3.43	60	2.36	60	2.36	27	1.06	101	3.98	93	3.66	34	1.34
160	6	115	4.53	78	3.07	78	3.07	40	1.57	161	6.34	-	-	-	-

Back Flange Mounting

Front Flange Mounting

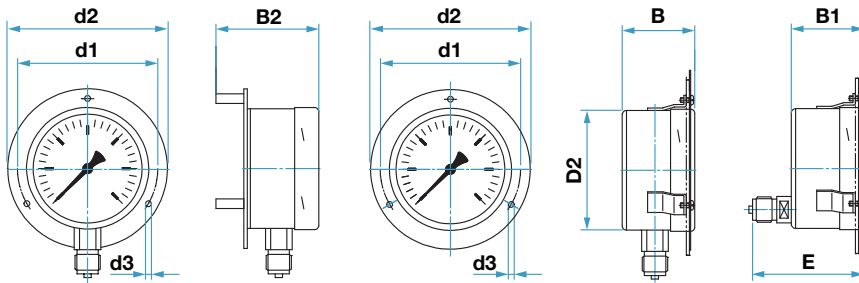

Case Size		B2		d1		d2		d3	
mm	inch	mm	inch	mm	inch	mm	inch	mm	inch
63	2/1 2	61	2.4	75	2.95	85	3.35	3.6	0.14
100	4	85	3.35	116	4.57	132	5.2	4.8	0.19
160	6	108	4.25	178	7.01	196	7.72	5.8	0.23



**PROCESS
PRESSURE GAUGES**

IMPP
SERIES

**P**HAM-LET IMP GAUGES **P** SERIES

IMP**P** series

data sheet:

General:

The Industrial, P – Process pressure gauge is a heavy duty pressure gauge with a special thermoplastic safety case for process industries, chemical, petro-chemical, gas and oil, and power plant applications with accordance to the ASME B40.1 standard.

The reinforced thermoplastic case and stainless steel wetted parts make the P pressure gauge suitable for service in corrosive areas and with aggressive media while maintaining a long life and durability for indoor and outdoor process applications.

The safety pattern case has a break-proof solid front (a firm partition between the pressure element and the window) and a pressure relief back (blow-out back).

The P series pressure gauge is a bourdon tube mechanical devices, of case sizes 4½" (115 mm). suitable for vacuum to pressure up to 1000 bar (15,000 psi).

Features:

- Thermoplastic case with back mounting design.
- Stainless steel wetted parts.
- Adjustable pointer (Micro pointer) for easy adjustment.
- Break-proof solid front case with blow-out back.
- Safety laminated glass front.
- Case is filled or fillable.
- Case protection: IP 65.
- Compliance to ASME B40.1 standard grade 2A .
- Fire retardant and impact resistance according UL 94 VO.

Measuring ranges



- Vacuum: 30" Hg Vac. to 0 psi (-1 to 0 bar)
- Compound: 30" Hg Vac. through 0 to 300 psi (-1 through 0 to 15 bar)
- Pressure: 0 to 15,000 psi (0 to 1,000 bar).



Materials Of Construction

Part		Material
Wetted Parts:	Process connection	SS 316L
	Bourdon tube	
Case		Thermoplastic PBTP Black
Window		Laminated safety glass
Movement		Stainless Steel
Dial		Aluminum (black figures, white background)
Pointer		Aluminum (black)

Technical Data P Series

Case Size	4½" (115 mm)	
Accuracy	Up to 15,000 psi (1000 bar) (2)	±0.5% of span EN 837-1 Class 1.0 ASME B40.1 Grade 2A
Case Configurations	Process connection position	
	Built in Mounting	
Process Connection	½", 12mm Tube adapter	+
	½" BSP-P/NPT	+
	¼" BSP-P/NPT	+
Blow-Out Device	Blow-out back	+
Compensation Diaphragm	By blow-out device / Plug	+
	Internal Elastomer	+
Weight (1) Pound (Kg.)	Unfilled	1.88 (0.85)
	Filled	2.76 (1.25)

(1) Approx. without mounting device

(2) See Maximal pressure per connection type, page 3

(3) Available in filled or fillable version only



P

Configuration And Mounting Dimensions

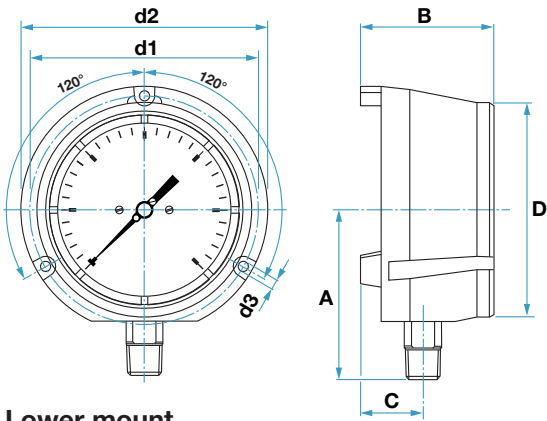

Lower mount

Case Size		A		B		C		D		d1		d2		d3	
mm	inch	mm	inch	mm	inch	mm	inch	mm	inch	mm	inch	mm	inch	mm	inch
115	4 1/2	102	4.02	80	3.15	37.5	1.48	129	5.08	137	5.39	148	5.83	6.1	0.24



**LOW PRESSURES
PRESSURE GAUGES**

IMPL
SERIES



IMPL series

data sheet:

General:

The Industrial, L – Low pressures gauge series are gaseous media positive and negative low pressures measurement devices with long usability and durability for indoor, outdoor and harsh surroundings, industrial, instrumentation and process applications.

The L series pressure gauges is a capsule mechanical device, Case sizes 63, 100, 160mm (2½”, 4”, 6”) are suitable for vacuum to pressure up to 250inchH2O (600mbar)

Features:

- All stainless steel case and wetted parts.
- Bayonet ring.
- Front-sided screw for zero point adjustment with an adjusting range of ±5%.
- Case is filled or dry.
- Case protection: IP 54.
- Measuring ranges
 - Vacuum/ Pressure: 0-1inchH2O up to 0-250inchH2O (0-2.5mbar up to 0-600mbar)
 - For case size 63mm (2½”) 0-25inchH2O (0-25mbar) and up.
 - Compound: -0.4-06inchH2O up to -150-100inchH2O (-1-1.5mbar up to -400-200mbar)
 - For case size 63mm (2½”) -4-6inchH2O (-10-15mbar) and up.
- only for dry and filled case

Materials of Construction

Part		Material
Wetted Parts	Process connection	SS 316L
	Bourdon Tube	
Case		SS 304
Window		Laminated safety glass
Movement		Stainless steel
Dial		Aluminum (black figures, white background)
Pointer		Aluminum (black)

PRESSURE GAUGES

HAM-LET IMP GAUGES L SERIES



Technical Data L Series

Case Size		63mm (2½")	100mm (4")	160mm (6")
Accuracy		±1.6% of span EN 837-1 Class 1.6 ASME B40.1 Grade B	±1.6% of span EN 837-1 Class 1.6 ASME B40.1 Grade 1A	±1.6% of span EN 837-1 Class 1.6 ASME B40.1 Grade 1A
Case Configurations	Process connection position			
	Mounting device (Optional)			
Process Connection	½", 12mm Tube adapter		+	
	3/8", 10mm Tube adapter	+		
	¼", 6mm Tube adapter	+		
	½" BSP-P/NPT		+	+
	¼" BSP-P/NPT	+	+	+
	1/8" BSP-P/NPT	+		
	M20x1.5		+	+
M12x1.5	+	+	+	
Case Ventilation Filled Only	By blow -out device		+	
Weight (1) Pound (Kg.)	Unfilled	0.44 (0.20)	1.32 (0.60)	2.20 (1.00) (2)
	Filled	0.57 (0.26)	2.09 (0.95)	3.97 (1.80) (2)

(1) Approx. without mounting device.

(2) For 160mm (6") ≥ 25mbar - Unfilled 2.09 (0.95), Filled 3.97 (1.80).

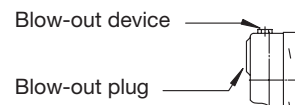



Configuration And Mounting Dimensions

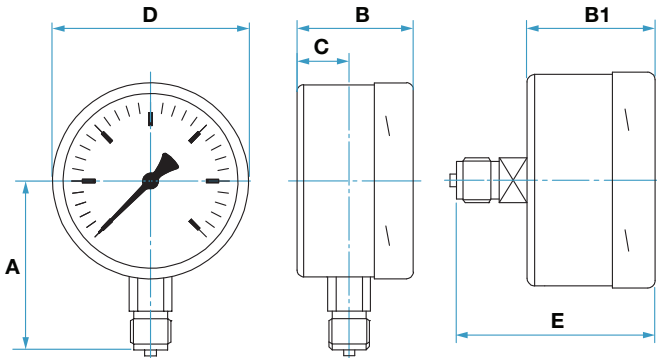

Lower Mount

Lower Back Mount

Case Size		A		B		B1		C		D		E	
mm	inch	mm	inch	mm	inch	mm	inch	mm	inch	mm	inch	mm	inch
63	2 1/2	54	2.13	38 (1)	1.5(1)	37	1.46	10	0.4	64	2.52	60	2.36
100	4	87	3.43	55	2.17	55	2.17	20 (2)	0.79 (2)	101	3.98	85	3.35
160	6	115	4.53	55	2.17	55	2.17	15	0.59	161	6.34	85	3.35
≤6 inCH ₂ O (16mbar)				51	2.01	51	2.01	15	0.59	161	6.34	81	3.18
160	6	115	4.53	51	2.01	51	2.01	15	0.59	161	6.34	81	3.18
≥10 inCH ₂ O (25 mbar)													

Back Flange Mounting

Front Flange Mounting

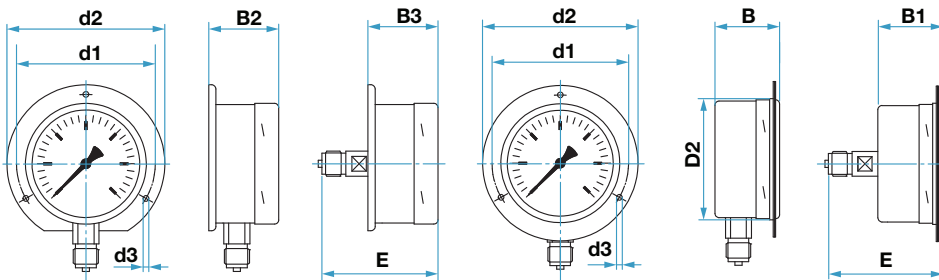

Case Size		B2		B3		D2		d1		d2		d3	
mm	inch	mm	inch	mm	inch	mm	inch	mm	inch	mm	inch	mm	inch
63	2 1/2	41 (1)	1.61 (1)	40	1.57	66	2.6	75	2.95	85	3.35	3.6	0.14
100	4	59	2.32	59	2.32	103	4.06	116	4.57	132	5.20	4.8	0.19
160	6	58	2.28	58	2.28	163	6.42	178	7.01	196	7.72	5.8	0.23
≤6 inCH ₂ O (16mbar)		54	2.13	54	2.13	163	6.42	178	7.01	196	7.72	5.8	0.23
160	6												
≥10 inCH ₂ O (25 mbar)													

(1) For case size 63 filled: B=47 mm (1.85 inch), B2=50 mm (1.97 inch)

(2) For range ≤ 6 inCH₂O (16mbar): C=15.5 mm (0.61 inch)

Ordering Information For Industrial Mechanical Pressure Gauges

OPTIONAL

See page 29

IMP - Industrial Mechanical Pressure gauge

H - Series

10 - Gauge size

L - Process Connection Location

P - Process Connection Type

1/4 - Connection Size

N - Mounting Device

B - Mounting Device

PO25 - Case

E - Case

Dial Range

Dial Range Units*

Case

Series

Series	
H - Heavy duty	
G - General use	
S^o - Safety pattern	
L⁽¹⁾ - Low pressures	
P⁽²⁾ - Process	



(1) "L" cannot go with "E" case
 (2) not in "D" case
 (3) Lower back connection available only for dry option

Process Connection Type

Connection type	Connection Size	
P - BSP-P	1/8, 1/4, 1/2	inch
N - NPT	1/8, 1/4, 1/2	inch
M - Metric (Mx1.5)	12M, 20M	mm
T⁽³⁾ - Tube adapter	06M,10M,12M	mm
	1/4 ,3/8 ,1/2	inch
V⁽⁴⁾ - Face Seal Male swivel	1/4	inch
F⁽⁴⁾ - Face Seal Female swivel	1/4	inch
H - High pressure Male	916	(9/16) inch
	High pressure Female	1/4 16m
		inch mm

(3) "T" 50mm and up
 (4) "V"+"F" only in "D" case

Process Connection Location

L	Lower mount	
B	Lower Back mount	
C	Center Back mount	

Mounting Device

N - None
R - Rear Flange
F - Front Flange
U - U - Clamp

Dial Range Units*

B - bar
P - psi
M - milibar
K - kPa
I - MPa
H - inH ₂ O
A - psi/bar
C - psi/kPa
D - psi/kgfcm ²
E - bar/psi
F - MPa/bar
G - kPa/H ₂ O
T - Meter
L - kgfcm ²
O - mm H ₂ O
S - Atmosphere

Case

D - Dry
E - Fillable (Empty)
G - Glycerin (99%)
L - Low Temperature Glycerin (86%)
S - Silicon Oil

Dial Range

See Table page 28

***Primary / Secondary units**

Primary
 Black outer scale, defines the gauge range

Secondary
 Red inner scale, corresponds with gauge range

Gauge size

	mm	inch
40 -	40	1 1/2
50 -	50	2
63 -	63	2 1/2
10 -	100	4
11 -	115	4 1/2
16 -	160	6

Ordering Information For Certification

Accuracy, Material and various standards conformance certifications are available for ordering.

IMP - Industrial Mechanical Pressure gauge

C - Certificate

31 - Class⁽⁶⁾

M - Category

Blank - Type

Class⁽⁶⁾

00 - General
21 - 2.1 ⁽¹⁾ - Pass / fail
22 - 2.2 ⁽¹⁾ - Inspection
31 - 3.1 ⁽¹⁾⁽²⁾ - Test Results, Item approval

(1) According EN10204 (2) Material certificate 3.1 is available for 50 mm & up. (3) Per item (serial No.) (4) Per item type (5) Per order.
 (6) Category per class:
 21-M,T | 22-A,M,S,T | 31-M,S,T

Category

A - Accuracy ⁽⁵⁾
M - Material ⁽²⁾⁽⁴⁾
S - Standard conformance ⁽⁵⁾
T - Quality Test

Type

Blank - General
GC - GOST - Customs declaration Russia
GR - GOST - R
TR - GOST-Type Russia
TU - GOST-Type Ukraine
TK - GOST-Type Kazakhstan
S - Standard conformance
BP600 - Up to 600 bar (10,000 psi) scale
BP01K - Up to 1000 bar (15,000 psi) scale

Warning!

The system designer and user have the sole responsibility for selecting products suitable for their special application requirements, ensuring their safe and trouble-free installation, operation, and maintenance. Application details, material compatibility and product ratings should all be considered for each selected product. Improper selection, installation or use of products can cause property damage or personal injury.

Dial Range Ordering Codes

H,G,S,P Series								
bar			psi			MPa		
Code	Min.	Max.	Code	Min.	Max.	Code	Min.	Max.
V001	-1	0	V001	30" Hg vac.	0	V000	-0.1	0.00
VP60	-0.6	0	C015	30" Hg vac.	15			
CP60	-1	0.6	C030	30" Hg vac.	30	CP06	-0.1	0.06
C1P5	-1	1.5	C060	30" Hg vac.	60	CP15	-0.1	0.15
C003	-1	3	C100	30" Hg vac.	100	CP30	-0.1	0.30
C005	-1	5	C160	30" Hg vac.	160	CP50	-0.1	0.50
C009	-1	9	C200	30" Hg vac.	200	CP90	-0.1	0.90
C015	-1	15				C1P5	-0.1	1.50
			P315	3	15			
PP21	0.2	1	P010	0	10			
PP60	0	0.6	P015	0	15			
P001	0	1				PP10	0	0.1
P1P6	0	1.6	P030	0	30	PP16	0	0.16
P2P5	0	2.5	P060	0	60	PP25	0	0.25
P004	0	4	P100	0	100	PP40	0	0.40
P006	0	6	P160	0	160	PP60	0	0.60
P010	0	10	P200	0	200	P001	0	1
P016	0	16	P300	0	300	P1P6	0	1.6
P025	0	25	P600	0	600	P2P5	0	2.5
P040	0	40	P800	0	800	P004	0	4
P060	0	60	P01k	0	1,000	P006	0	6
			P1k5	0	1,500			
P100	0	100	P02k	0	2,000	P010	0	10
P160	0	160	P03k	0	3,000	P016	0	16
P250	0	250	P04k	0	4,000	P025	0	25
			P05k	0	5,000			
P400	0	400	P06k	0	6,000	P040	0	40
			P10k	0	10,000			
P600	0	600				P060	0	60
P01k	0	1,000	P15k	0	15,000	P100	0	100

L Series								
Milibar			kPa			in H2O		
Code	Min.	Max.	Code	Min.	Max.	Code	Min.	Max.
V600	-600	0						
			V050	-50	0	V200	-200	0
V400	-400	0						
V250	-250	0				V100	-100	0
			V020	-20	0			
V160	-160	0						
			V015	-15	0	V060	-60	0
V100	-100	0						
			V007	-7	0	V030	-30	0
V060	-60	0						
			V005	-5	0	V020	-20	0
V040	-40	0	V004	-4	0	V015	-15	0
V025	-25	0						
V016	-16	0						
V010	-10	0						
V006	-6	0						
V004	-4.0	0						
V2P5	-2.5	0						
C200	-400	200						
C400	-200	400						
C150	-250	150						
C250	-150	250						
C100	-150	100						
C115	-100	150						
C160	-100	60						
C610	-60	100						
C040	-60	40						
C060	-40	60						
C020	-40	20						
C240	-20	40						
C015	-25	15						
C025	-15	25						
C010	-15	10						
C105	-10	15						
P003	0	3						
P004	0	4						
P006	0	6						
P010	0	10						
P016	0	16						
P025	0	25						
P040	0	40	P004	0	4	P015	0	15
			P005	0	5	P020	0	20
P060	0	60						
			P007	0	7	P030	0	30
P100	0	100						
			P015	0	15	P060	0	60
P160	0	160						
			P020	0	20			
P250	0	250						
P400	0	400				P100	0	100
			P050	0	50	P200	0	200
P600	0	600						

PRESSURE GAUGES

Options Ordering Codes

P		T		L		N		E		Y		6		X		R					
Additional elements		Specials														Restriction screw		Variations		Special compatibility	
Blank	None	Blank	None	Blank	None	Blank	None	Blank	None	Blank	None	Blank	None	Blank	None	Blank	None				
P [*] - Fix Pointer		T - Measuring point SS Plate		L ⁽¹⁾⁽²⁾ - Lubricant free		N - Alloy 400 wetted parts		E - Helium leak test		Y - Vibration resistant movement		0 - Ø 0.0mm		W - Pure gases		G - GOST - version					
M [*] - Min/Max Pointer				S - Silicon free				V - ATEX				3 - Ø 0.3mm		A - Absolute pressure		R - GOST-T - Russia					
				X ⁽³⁾⁽⁴⁾ - oxygen cleaning**								4 - Ø 0.4mm		Z - Grade 3A (ASME)		U - GOST-T - Ukraine					
												6 - Ø 0.6mm				K - GOST-T - Kazakhstan					
												8 - Ø 0.8mm									

*Only possible for IMPH63
**Except the 50 mm gauges (L,S,X-up to 600 bar)
"L"⁽¹⁾ only in "D" & "E" case "X"⁽³⁾ only in "D"
"L"⁽²⁾ IMPP only for "D" case "X"⁽⁴⁾ size 160mm only in IMPS

Additional Elements

Fix Pointer: additional red pointer pointing to a designated pressure on the dial. The fix pointer dose not move with the measured pressure changes and it is used to point a fixed measure on the dial for the user.

Min/Max Pointer: additional red pointer pointing to the minimal or maximal pressure that was pointed to by the gauge main pointer. The Min/Max pointer has a mechanism to reset its position to the initial read ("0" read). The Min/Max pointer is moves with the main gauge pointer to the minimal or maximal pointing position and remains in this position when the pressure read is raises / drops respectively and it is used to point to the minimal / maximal pressure read over time.

Material heat stamp: is required whenever a Material certificate level 3.1 is requested to be supplied with the gauge. (See "Certification" for more information on Material certificate).

Specials

Lubricant free: The gauge is specially cleaned to have no oil leftovers on its internals. The lubricant free gauge is marked with a  icon on its dial.

Silicon free: The gauge is specially cleaned to have no silicon leftovers on its internals.

Alloy 400 wetted parts: The gauge wetted parts are made of Alloy 400. Alloy 400 wetted parts are frequently used for measuring highly corrosive media. Other special wetted parts materials are available.

Helium leak test: The gauge is tested for leakage of up to 10⁻⁹ mbar l/s using pressurized Helium.

Restriction Screw:

A restriction screw with the designated bore is installed at the gauge media inlet, the restriction screw installation and

firmly fixing is done at the manufacturing plant. The restriction screw is one mean of protecting the gauge from pulsating or temporary high pressures and it slows down the gauge pointer reaction to pressure changes.

A gauge with a restriction screw should be more carefully checked for its inlet being free of blockage by particles, viscous media or other obstacles.

Variations

Oxygen version: The gauge is specially made to be used for oxygen measurement.

Special Compatibility:

The Gauge is manufactured to be compatible to the designated standard or regulation. A special compatible gauge is marked as required by the designated standard.

Mounting Device

Rear Flange: The metal flange on the back of the gauge case is used to firmly mount the gauge on a panel/wall or any other fixing. The back flange is a firmly welded part of the gauge case and it guaranties the best support for the gauge.

Front Flange: The metal flange on the front of the gauge case is used to firmly mount the gauge on a panel or any other fixing with a hole to host the gauge. The front flange is a firmly welded part of the gauge case and it guarantees the best support for the gauge.

U-Clamp: The metal U shaped clamped with two fixing bolts supports the gauge from the back side of a panel hosting the gauge.





Accessories

Flame Arrester (ATEX Approved)

Flame Penetration Protection

Function

The Flame arrester avoids a flame penetration at deflagrations of potentially explosive vapor-air resp. gas-air mixtures of explosion hazardous IIA, IIB and IIC in an upstreamed volume (e.g. pressure measuring instruments, chemical seals or similar).

Explosion Protection

The deflagration volume protection device corresponds as non-electrical equipment for potentially explosive areas with the harmonized norm DIN EN ISO 16852 "Flame Penetration Protection". It is examined and approved as flame penetration protected at deflagration of flammable gases and liquids, according to EC-Type Examination Certificate / Approval PTB 12 ATEX 4001 X Explosion Protection Class IIG IIC. The corresponding marking according to ATEX 94/9/EG is made at a suitable position of the instrument.

Construction:

as screw-adapter
1/2" BSP-P internal x 1/2" BSP-P
(others upon request)



See
HAM-LET
ASTAVA
Manifolds
catalog

Pressure Gauge Cocks

Cocks Models

Class	DIN 16262		DIN 16263	
Type	M20x1.5	1/2" BSP-P	Test Flange 60x25x10mm (2.36x0.98x0.39 inch)	Test Connection Male Thread M 20x1.5
Process Connection	Male thread M 20x1.5	Male thread 1/2" BSP-P		
Instrument Connection	Clamping sleeve female M20x1.5	Clamping sleeve female 1/2" BSP-P		
Nominal Pressure	PN 16			
Handle	Plastic			
Material	- Brass (Clamping sleeve alloy steel phosphatized) - Alloy steel - Stainless steel 316 (1.4571)			

Applications

Fluid or gaseous media resp. steam at temperatures between -10 °C to +50 °C (14 °F to 122 °F) ;
For connecting to a pressure gauge with flat sealing ring EN 837 (DIN 16 258).

Over Range Protector

The over range protector is a piston valve. The piston will remain in an "open" position as long as the pressure of the medium is lower than the back pressure imposed on the piston by the spring. As medium pressure accedes the spring back pressure, the piston will move towards the spring and the piston valve closes. After the medium pressure decreases by approximately 25% below the set closing pressure, the valve opens and the spring force causes the piston to return to its original "open" position.

The over range protector has been designed to protect pressure gauges against a pressure overload higher than the measuring range. It allows putting several gauges with different pressure ranges in ascending stages and makes it possible to read even low ranges in a precise way, when the total range is in fact much higher. The valves are not suitable for use as regulators.

Models: Brass, Stainless steel.

Available Ranges:	
PSI	BAR
3-35	0.4-2.5
30-85	2-6
75-350	5-25
300-850	20-30
750-3600	50-250
3500-5800	240-400

HAM-LET INDUSTRIAL MECHANICAL PRESSURE GAUGES

Pressure Gauge Valves

According to DIN 16270, DIN 16271 with Male Test Connection, and with Test Flange

Valves Models

Versions	Type	Process Connection	Gauge Connection	Test Connections
DIN 16 270	BSP-P	½" BSP-P male	adjusting nut ½" BSP-P female	M 20x1,5
	Metric	M20x1,5 male	adjusting nut M20x1,5 female	
DIN 16 270 with fitting for gauge holder bracket	BSP-P	½" BSP-P male	turnable nut ½" BSP-P female	
DIN 16 271	BSP-P	½" BSP-P male	adjusting nut ½" BSP-P female	
	Metric	M20x1,5 male	adjusting nut M20x1,5 female	
DIN 16 271 with fitting for gauge holder bracket	BSP-P	½" BSP-P male	turnable nut ½" BSP-P female	
Similar to DIN 16 271 with test flange	BSP-P	½" BSP-P male	adjusting nut ½" BSP-P female	flange 60 x 25 x 10 mm

Material of construction

Versions	Brass	Alloy Steel	Stainless Steel	
All Models	Material (DIN material numbers)			
	Body	Brass	SS (1.0460)	SS (1.4571)
	Valve spindle	SS (1.4104)		
	Valve cone	SS (1.4034 hardened)		
	Packing	PTFE	Graphite	PTFE
	Union nut	Alloy steel		SS (1.4571)
	Adjusting nut			
	Turnable nut	Brass	Alloy steel	
	Vent screw	SS (1.4104)		
	Hand wheel	Plastic		
Temperature rating	-10 / + 120 °C (14 / 248 °F)		-40 / +200 °C (-40 / +392 °F)	

Ball Shock Absorber

Ball shock absorbers are designed to protect pressure instruments against re impacts.

In case of pressure drops or pressure peaks the media moves the stainless steel ball within the inlet port and damps the appropriate bore.

The counter direction has free flow.

In case of order it must be clarified if the ball shock absorber is used for pressure peaks (marked with + on the body) or pressure

drops (marked with - on the body)

Construction:

Made of 316L stainless steel or brass with male and female thread 1/2" BSP or NPT.

Application:

Material test machines, hydraulic accumulators, hydraulic clamping devices.

Industrial Mechanical Pressure gauges | 2020_Rev00

