

MTL SUM5™

Smart Universal Marshalling



DECLARATION OF CONFORMITY

A printed version of the Declaration of Conformity has been provided separately within the original shipment of goods. However, you can find a copy of the latest version at-

<http://www.mtl-inst.com/certificates>

CONTENTS

	DECLARATION OF CONFORMITY	ii
	IMPORTANT NOTES	v-vii
1	INTRODUCTION	1
1.1	General	1
1.2	The MTL SUM5 range of modules concept	2
2	MTL SUM5 RANGE DESCRIPTION	2
2.1	UI Module	3
2.2	Module Base	3
2.3	Standard Carrier	4
2.4	System Specific Carrier	4
2.5	Alarm modules	5
2.6	Surge protection	5
2.7	Unused module bases	5
3	INSTALLATION – PRECAUTIONS	6
3.1	General	6
3.2	Preliminary notes	6
4	CARRIER INSTALLATION	7
4.1	DIN-rail mounting	7
4.2	Surface mounting	8
4.3	System wiring	8
4.4	Identification and tagging	8
4.5	Carrier earth protection	9
4.6	DC power connection	10
4.7	Power and heat considerations	11
5	INSTALLATION – MODULES	12
5.1	Terminals – pre-installation	12
5.2	Terminals – installation and removal	13
5.2.1	Terminal base installation	13
5.2.2	Field wiring	14
5.2.3	UI module installation	14
5.3	UI module LED indicators	15
5.3.1	Mode indicator (M)	16
5.3.2	Status indicator (S)	16
5.4	Manual configuration with push button	17
5.5	Surge-protection module installation	18
5.6	Ground module installation	18
5.7	Fitting Surge or Grounding module	19
5.8	Fitting MTL4-LNKIS link LK1	19
6	UI CONFIGURATIONS AND CONNECTIONS	20
6.1	Digital input (DI)	20
6.2	Digital output (DO)	21
6.3	Digital output (DO- with switched contacts)	21
6.4	Analogue input (AI)	22
6.5	Analogue output (AO)	23
6.6	Bypass module	23
6.7	Alarm module(s)	24
6.8	Loop disconnect	25

7	FAULT FINDING AND ROUTINE MAINTENANCE	26
7.1	Fault finding	26
7.2	Routine maintenance	26
8	APPENDIX A	27
8.1	I/O Parameters – MTL4-BSIS IS Module Base & MTL4-ADIO Interface Module. . .	27-28
8.2	Load Parameters	29
9	APPENDIX B	30
9.1	Fault finding	30
10	APPENDIX C	31
10.1	Ordering information	31

IMPORTANT NOTES

This manual describes the installation and use of the

- **MTL SUM5 range of MTL4 universal IO modules**

The MTL4 range products are intended not only for protection of hazardous areas in process plants that apply Intrinsic Safety techniques, but are also for use in safe-area applications.

The two application types are distinguished by the colour of the module base:

- **Blue** – is used for intrinsic safety applications
- **Grey** – is used for safe area applications

To ensure both the segregation of equipment and the requisite separation of wiring, operation and maintenance activities, these two types of module base **MUST NOT** be mounted on the same backplane.

The use of separate backplanes for I.S. and non-I.S. signals when installing the different application types ensures the segregation of I.S. and non-I.S circuits.

MTL SUM5 range of MTL4 universal IO module products

	WARNING! This manual has content describing the use and installation of safety equipment. This equipment must be installed, operated and maintained only by trained competent personnel and in accordance with all appropriate international, national and local standard codes of practice and site regulations for intrinsically safe apparatus and in accordance with the instructions contained here. Safety may be impaired if equipment is not used in accordance with these instructions.
---	--

	WARNING! This product contains high powered optical LEDs with power levels equivalent to a Class 1M laser according to IEC 60825-1:2014. These devices are embedded within the product, are inaccessible, and present no eye safety risk unless the product is opened or damaged during operation. If this occurs, do not view light sources directly with optical magnifying devices.
---	--

ATEX

If the country of installation is governed by the Essential Health and Safety Requirements (Annex II) of the EU Directive 2014/34/EU [the ATEX Directive - safety of apparatus] then consult the ATEX safety instructions for safe use in this manual before installation.

Note: Refer to the website for multiple language safety instructions.

ELECTRICAL PARAMETERS

Refer to the certification documentation for the electrical rating of these products.

CERTIFICATION DOCUMENTATION

Our website <http://www.mtl-inst.com> contains product documentation regarding intrinsic safety certification for many locations around the world. Consult this data for information relevant to your local certifying authority.

FUNCTIONAL SAFETY

If the MTL4 range products are required for functional safety applications check that they have been assessed for that service and refer to the Safety Manual for details.

REPAIR

MTL4 range products **MUST NOT** be repaired. Faulty or damaged products must be replaced with an equivalent certified product.

CLEANING

Should modules require cleaning, use water only on a damp cloth.

Symbols used on the product and in this manual



CAUTION - Read the instructions

ATEX SAFETY INSTRUCTIONS

The following information is in accordance with the Essential Health and Safety Requirements (Annex II) of the EU Directive 2014/34/EU [the ATEX Directive - safety of apparatus] and is provided for those locations where the ATEX Directive is applicable.

General

- a) This equipment must only be installed, operated and maintained by competent personnel. Such personnel shall have undergone training, which included instruction on the various types of protection and installation practices, the relevant rules and regulations, and on the general principles of area classification. Appropriate refresher training shall be given on a regular basis. [See clause 4.2 of EN 60079-17].
- b) This equipment has been designed to provide protection against all the relevant additional hazards referred to in Annex II of the directive, such as those in clause 1.2.7.

Installation

- a) The installation must comply with the appropriate European, national and local regulations, which may include reference to the IEC code of practice IEC 60079-14. In addition, particular industries or end users may have specific requirements relating to the safety of their installations and these requirements should also be met. For the majority of installations, the Directive 1999/92/EC [the ATEX Directive - safety of installations] is also applicable.
- b) This apparatus is an associated electrical apparatus and is normally mounted in a non-hazardous [safe] area.
- c) Unless already protected by design, this equipment must be protected by a suitable enclosure against:
 - i) mechanical and thermal stresses in excess of those noted in the certification documentation and the product specification
 - ii) aggressive substances, excessive dust, moisture and other contaminants.

Read also the Special Conditions for Safe Use (below) for any additional or more specific information.

Special Conditions of Safe Use

- 1) The non-hazardous area connections of the equipment must be supplied from either safety extra low-voltage (SELV) or protective extra low-voltage circuits, for example equipment complying with the requirements of either the IEC 60950 series, IEC 61010-1 or a technically equivalent standard.
- 2) When fitted with the optional surge module the equipment is not capable of withstanding the 500V dielectric strength test required by clause 6.3.13 of IEC 60079-11: 2011 / EN 60079-11: 2012. This must be taken into account when installing the equipment.

Inspection and maintenance

a) Inspection and maintenance should be carried out in accordance with European, national and local regulations which may refer to the IEC standard IEC 60079-17.

In addition, specific industries or end users may have specific requirements which should also be met.

b) Access to the internal circuitry must not be made during operation.

Repair

a) This product cannot be repaired by the user and must be replaced with an equivalent certified product.

Marking

Each device is marked in compliance with the Directive and CE marked with the Notified Body Identification Number.

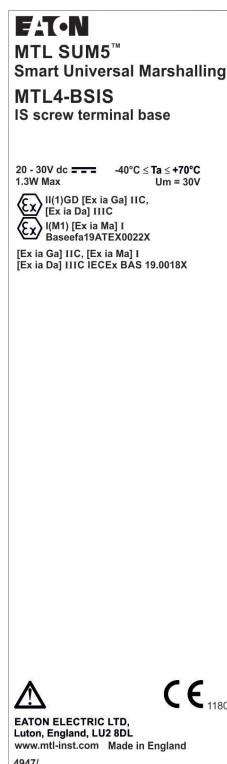

MTL4- BSIS product label



MTL4- ADIO product label

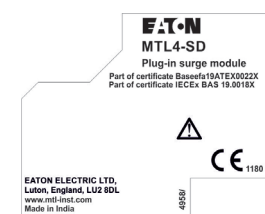

MTL4- SD product label

This information applies to MTL4 products manufactured during or after the year 2019.

THIS PAGE IS LEFT INTENTIONALLY BLANK

1 INTRODUCTION



1.1 General

This instruction manual describes the procedures for installing, connecting, checking and maintaining the MTL SUM5 range of MTL4 isolating interfaces and accessories that are mounted between the control room and the field instrumentation, or controls. The contents of this manual should be read in association with the latest product datasheet containing all of the necessary electrical data. This product range follows on from the well-established MTL 4000/4500 range of modules which were chosen individually for their functionality.

The MTL4 products are compact, universal isolator modules that may be used either as an intrinsically safe (IS) interface to the hazardous area of a process plant or, equally as well, as isolating interfaces for non-hazardous area service, the difference being merely the module base into which the isolator module is plugged.

The individual sections of the manual provide guidance on the following topics

- **Section 2** describes the range and its accessories
- **Section 3** specifies precautions before installation
- **Section 4** covers the installation of the carrier
- **Section 5** describes the installation of modules onto the carrier
- **Section 6** provides relevant configuration options
- **Section 7** outlines fault-finding and maintenance
- **Section 8** provides Safety Descriptions and Cable Parameters
- **Section 9** provides a list of key products with part numbers

1.2 The MTL SUM5 range of modules concept

The MTL4 range of modules and its accessories represent a simpler, general purpose approach to what used to be a more complex, tailored method of choosing individual isolating interfaces to suit the circuit type. The simplicity arises from the use of a 'universal' isolator that is mounted in a base chosen to suit the field wiring type, i.e. hazardous-area or safe-area (general purpose).

This new approach incorporates loop-disconnects and pluggable surge protection without any additional wiring. This not only reduces cabinet space, but dramatically reduces the number of hand-wired connections, thus removing many possible points of failure. Secondly, it drastically reduces spares inventory by the use of a single universal isolator interface for inputs, outputs, analogue or digital circuits.

The main module carrier can be chosen for general purpose screw-terminal connections or to suit the interfaces of existing control system manufacturers. Diagnostics and configuration control can be carried out remotely, significantly reducing installation and maintenance down-time.

2 MTL SUM5 RANGE DESCRIPTION

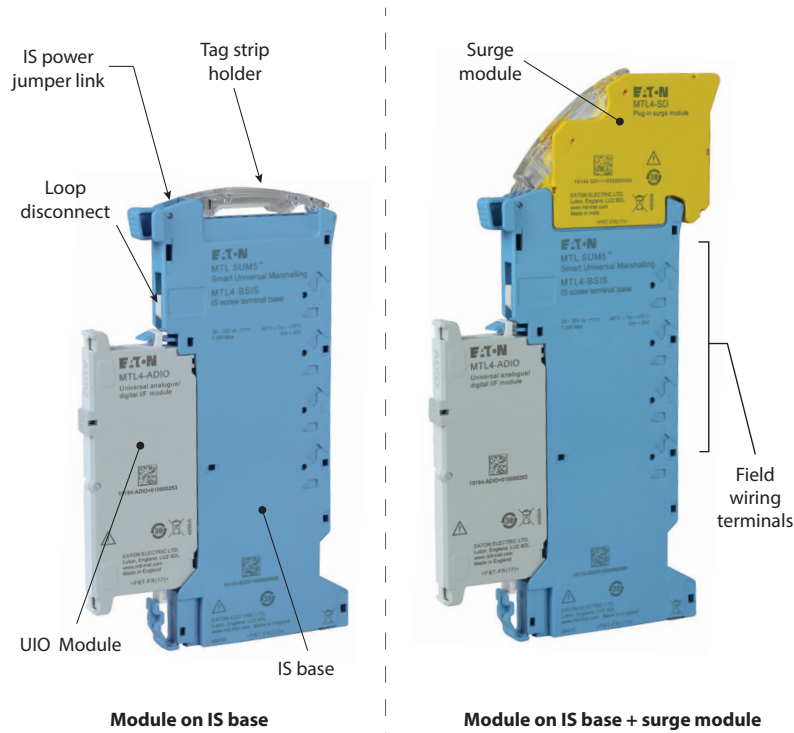

Figure 2.1 - UI module and base configurations

Refer to the diagrams for further details

2.1 UI Module

The universal isolator (UI) module is the heart of the interface. It plugs into the terminal base to provide the required isolation functionality. It can be configured for input or output operation as well as for digital or analogue applications.



WARNING!

Once an isolator module has been used in a general-purpose installation, it cannot subsequently be used as part of an IS installation

On its top edge are two LED indicators that provide module status and signal status.

A Bypass module is also available which provides a direct connection through the module from control wiring to field wiring. This is for use only with the General Purpose module base.

Model No.	Description
MTL4-ADIO	Universal analogue/digital I/F module
MTL4-BYP	Bypass module

2.2 Module Base

The base is the body of the channel interface. It accepts the field wiring on its rear edge, via screw terminals, and the universal I/O (UIO) module on its front edge. It has a loop disconnect facility built-in which may be levered outwards to isolate the field wiring from the UIO module.

On the top it has a hinged tag-strip holder with cover and a connector to accept a surge module (see below).

The base type is indicated by its colour:

Blue – IS module base

Grey – general purpose module base

A further option for both types is to have a relay included in the base to provide a switched output.

Model No.	Description
MTL4-BSIS	IS screw terminal module base
MTL4-BSISR	IS relay screw terminal module base
MTL4-BSGP	GP screw terminal module base
MTL4-BSGPR	GP relay screw terminal module base

2.3 Standard Carrier

The carrier is a platform on which the base modules are mounted. It is designed for DIN-rail mounting, but may also be surface mounted by the use of available clips (see Section 4.1). The carrier will accept up to 16 module bases as well as one, or two, alarm modules which can be added to provide contact closure for particular alarm events. The carrier has channel by channel connections to the main control equipment via screw terminals. It also has redundant power supply inputs and replaceable, plug-in, onboard fuses – see table below for type and replacement part number.

Model No.	Description
MTL4-CS16	16ch carrier, screw terminals + 1 alarm module position
FUS2.5ATE5	2.5A (T) replacement fuses (Pk 10)

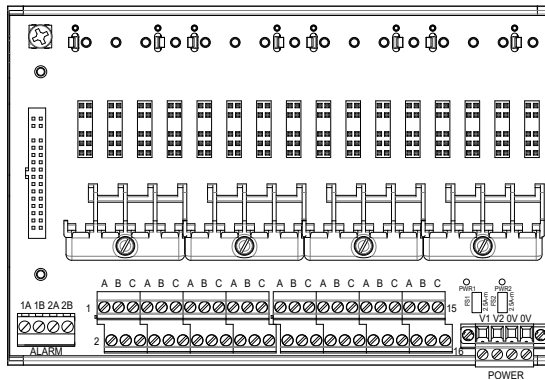

Figure 2.2 - Standard CS16 carrier configuration

2.4 System Specific Carrier

These carriers are generally the same format as the standard carrier except that, instead of the standard screw terminals, they have a system specific, multiway connector for the system cable. It also has redundant power supply inputs and replaceable, plug-in, onboard fuses – see table below for type and replacement part number.

Model No.	Description
MTL4-CSxxx	xxxxxxxxxx 16ch carrier, screw terminals + 1 alarm module position
FUS2.5ATE5	2.5A (T) replacement fuses (Pk 10)

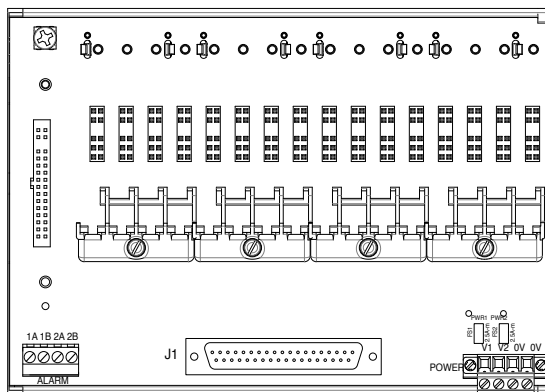

Figure 2.3 - An example of a 'system specific' carrier

2.5 Alarm modules

There are currently 2 types of alarm module, one containing relays, and one without relays. The non-relay version provides a configuration port and basic diagnostic alarming, while the other has, in addition, 16 relays that can provide contact or trip alarms for each of the isolator channels.

Model No.	Description
MTL4-DMA	Diagnostic Module Alarm
MTL4-DMR	Diagnostic Module Relay Alarm

2.6 Surge protection

This is a plug-in unit that provides surge protection for the channel to which it is fitted, with no additional wiring or cabinet space necessary. The relay version is designed for use with the relay base modules. The two model types are identical in shape and size. Consult the data sheet for all applicable ratings.

Model No.	Description
MTL4-SD	Plug-in surge module
MTL4-SDR	Plug-in relay surge module



Figure 2.4 - A surge-protection module



Figure 2.5 - A ground module

2.7 Unused module bases

Where field wiring has been installed in readiness for later expansion, a grounding module (MTL4-GND) can be installed to temporarily terminate the spare wiring and tie it safely to ground.

Model No.	Description
MTL4-ICC-50	Isolator connector cover (pk 50)
MTL4-GND	Ground module

3 INSTALLATION – PRECAUTIONS

3.1 General

Read this section before beginning to install carriers, modules etc.

3.2 Preliminary notes

- a) Make sure that all installation work is carried out in accordance with all relevant local standards, codes of practice and site regulations.
- b) When planning the installation of MTL4 range products it is essential to make sure that I.S. and non-I.S. wiring is segregated, as required by a nationally accepted authority or as described in EN 60079-14 or ISA RP 12.6.
- c) Ferrules used for stranded cables must be to DIN 46228 standard- suitable for 0.25 – 2.5mm² section stranded wire.
- d) Check that the hazardous-area equipment complies with the descriptive system document.
- e) If in doubt, refer to the certificate/catalogue for clarification of any aspects of intrinsic safety, or contact Eaton’s MTL product line or your local representative for assistance.
- f) Check that the interface function(s) are correct for the application(s).
- g) When plugging modules into backplanes and hazardous-area connectors into modules, check the identification labels to make sure the items match correctly.
- h) The non-hazardous area connections of the equipment must be supplied from either safety extra low-voltage (SELV) or protective extra low-voltage circuits, for example equipment complying with the requirements of either the IEC 60950 series, IEC 61010-1 or a technically equivalent standard.
- i) Environmental conditions: indoor use, altitude (up to 2000m) and humidity less than 95% non-condensing.
- j) The MTL4 products have an ingress protection rating of IP20.
- k) MTL4 products must be installed in an enclosure or cabinet with an impact rating of IK08 or better.

	<p style="text-align: center;">ESD HAZARD</p> <p>Electrostatic discharge can damage integrated circuits or semiconductors.</p> <ul style="list-style-type: none">• Touch a grounded object to discharge static potential• Wear an approved wrist-strap grounding device• When not in use, keep the component in its static shield box or bag
---	---

4 CARRIER INSTALLATION

4.1 DIN-rail mounting

The MTL4-CS16 and MTL4-DS16 carriers are designed for mounting in a control room equipment cabinet and are suitable for T section DIN-rail mounting in any orientation – but see also Section 4.5 for possible heat and power considerations when multiple carriers are mounted in a cabinet.

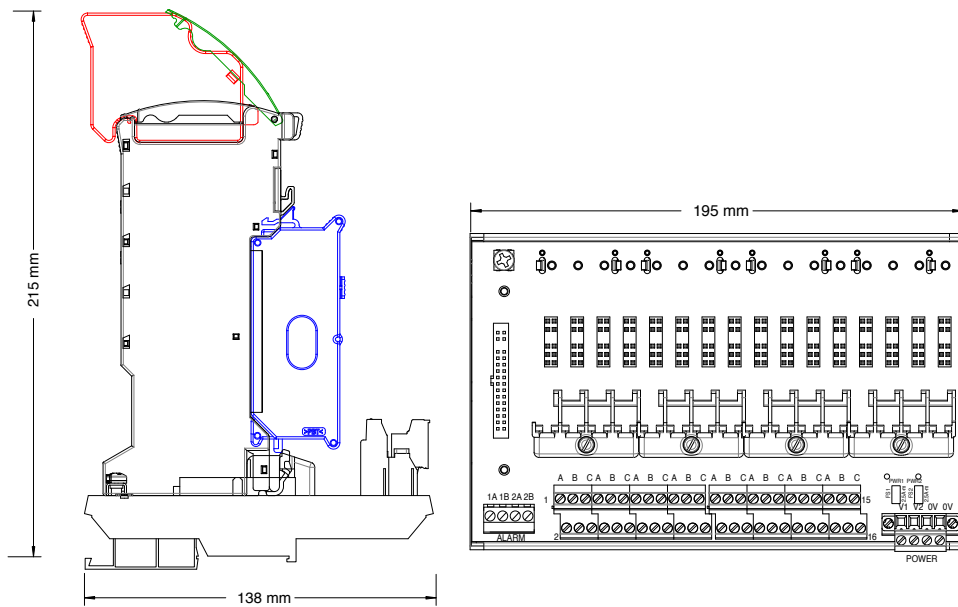

Figure 4.1 - Dimensions of standard carrier

The two dimensions given for the overall length of the carrier show the difference between the single alarm module carrier and the dual alarm module carrier – MTL4-CS16.

NOTE

When mounted, the overall height of the carrier from the underside of the DIN rail and excluding the surge protection module, will be 190mm.

4.2 Surface mounting

Clips are also available (MTL4-SMK-10- Pack of 10) that can be inserted into the ends of the carrier to enable the carrier to be surface mounted. See Figure 4.2 for dimensions and mounting details.

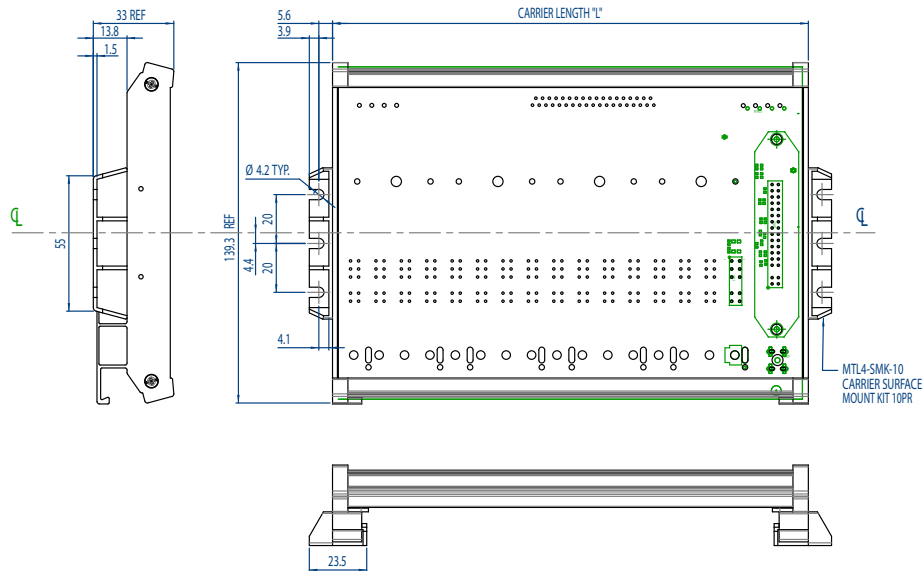

Figure 4.2 - Surface mounting dimensions for carrier

4.3 System wiring

The screw terminal blocks for the trunk fieldbus cables are suitable for cables 0.5mm²-4 mm² rigid core or 0.5mm²- 2.5mm² stranded.

NOTE

Cable ferrules to DIN 46228 standard must be fitted to any stranded cable or screen wiring that is being used.

Ferrules of length 6mm are recommended for the system wiring terminal blocks.

4.4 Identification and tagging

Each module base is supplied with a clear plastic tag holder that can be fitted with tagging strips to provide channel identity information.

The tag holder hinges on the UI module side. This may then be lifted up to insert an identity strip. When a surge protection module is required to be fitted, the tag holder can be lifted up on its hinge, the surge module plugged into the base module, and finally, the tag holder is lowered to clip onto the newly inserted surge protection module. Figure 4.3 helps to illustrate the end result.

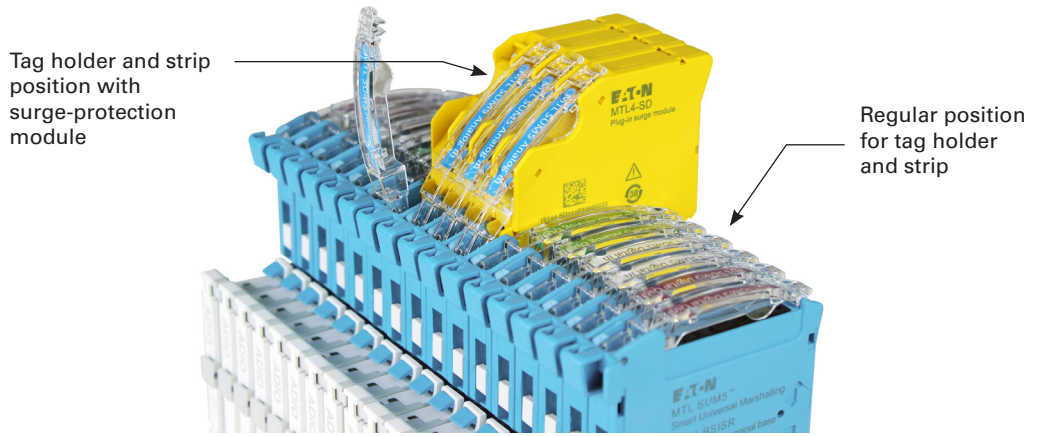

Figure 4.3 - Tagging strips in use

4.5 Carrier earth protection

All carriers must be earthed. Each carrier has a surge-ground screw, located to the rear of the alarm module – see Figure 4.4 below.

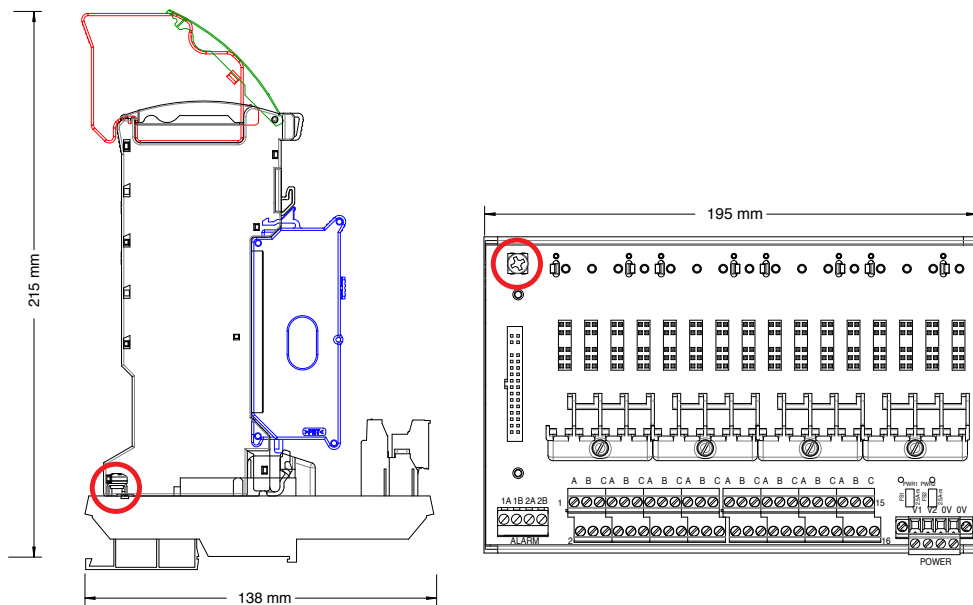

Figure 4.4 - Surge ground terminal – shown circled

This terminal is used to carry the surge current to ground if surge protection modules are used on the carrier. In these circumstances, it **MUST** be connected via a low impedance path to the plant ground. It is recommended that a cable with a cross-sectional area of at least 4mm², and a ring terminal be used to connect this screw terminal to the plant grounding bus.

4.6 DC power connection

Single or dual-redundant 24V (nom.) DC power supplies can be connected to each backplane using a removable, 4-way, screw-clamp terminal connector. Dual supplies are connected in parallel through diodes on the backplane, and bussed to the individual isolators. LEDs on the backplane will illuminate to show if the two independent supplies are operational. The use of diodes between the two supplies means that the one with the higher voltage is used at any given moment, and will ensure automatic switchover of supplies if one source fails.

The screw terminal connections for the power cables are suitable for cables 0.5mm²-4 mm² rigid core or 0.5mm²- 2.5mm² stranded.

NOTE

Cable ferrules to DIN 46228 standard must be fitted to any stranded cable or screen wiring that is being used.

Ferrules of length 10mm are recommended for use on the power supply terminal blocks.

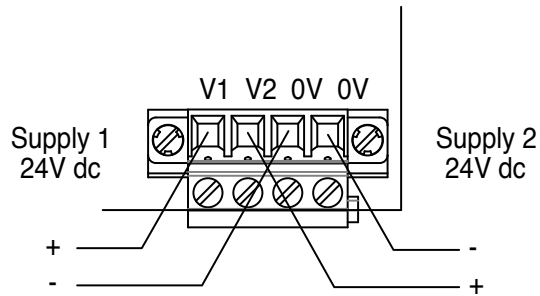

Figure 4.5 - Power supply wiring

4.7 Power and heat considerations

The power consumption for a single module base i.e. channel will depend upon the voltage used to supply the carrier and the mode in which the UI module is used. The table below gives a guide to the current drawn and the power dissipation, per channel, for the modes indicated. These figures may be used as a guide when calculating the total heat generation for each installation area and so determine any need for additional ventilation or active heat removal (fans).

	AI, AO, DI modes	DO mode
Current at 24V supply	45mA (typ.)	100mA (typ.)
Power dissipation	< 500mW	1W

The optimum orientation for carriers when determining heat dissipation, and for ambient temperatures in excess of 60°C, is to have the carrier mounted in a 'landscape' fashion with the channels numbering across horizontally. In situations when dissipation is not so critical or when forced cooling is provided, the carriers can be mounted with channels being 'stacked' one above each other in a 'portrait' orientation, as illustrated below in Figure 4.6.

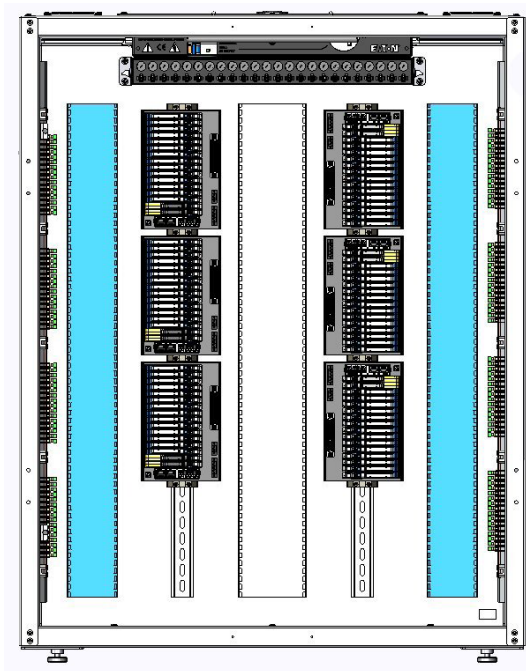

Figure 4.6 - A mounting suggestion to optimise wiring segregation

(for maximum I/O density a 3 column configuration may be used)

5 INSTALLATION – MODULES

5.1 Terminals – pre-installation

The module base must be chosen to match the status of the field wiring; intrinsically safe (IS) – blue module base, or general purpose (GP) – grey, see table below. The principle distinction between the two is that the MTL4-BSIS and MTL4-BSISR terminal bases contain the necessary diode and resistive components to provide the intrinsic safety protection for the hazardous-area field wiring.

After that, the only choice to be made is whether the module base requires a relay for a switched contact DO output.

Channel operation	Terminal bases – by application	
	I.S. field wiring (Zone 0, IIC, T4-6 hazardous area if suitably certified)	General purpose field wiring (Zone 2, IIC, T4-6 hazardous area if suitably certified)
AI	MTL4-BSIS	MTL4-BSGP
AO	MTL4-BSIS	MTL4-BSGP
DI	MTL4-BSIS	MTL4-BSGP
DO	MTL4-BSIS	MTL4-BSGP
DO - with switched contacts	MTL4-BSISR	MTL4-BSGPR



WARNING!

Do not install IS and general-purpose terminal bases on the same carrier!

5.2 Terminals – installation and removal

5.2.1 Terminal base installation

Follow the procedure below for either IS or general-purpose module bases.
(Note that this procedure can also be carried out with the UI module fitted.)

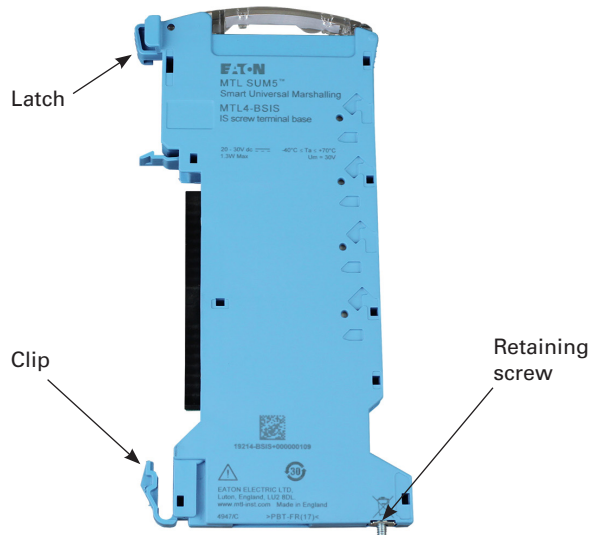

Figure 5.1 - Installing a terminal base

Push the terminal base vertically downwards into the carrier ensuring the base clip clicks into place and at the same time ensuring the upper latch is located into the mating part on the adjacent module, if one is fitted. Use a small-bladed screwdriver to locate and tighten the retaining screw.

NOTE

Ensure that the screw is adequately tight as the contact between the terminal base and the carrier board provides the ground path for any surge current.

Removal is the reverse of this sequence but the UI module must be removed first. Loosen screw, press clip inwards to release and pull base vertically off carrier.

5.2.2 Field wiring

The screw clamp terminals on the module base will accommodate wire cross-sectional areas from 0.5mm² - 4 mm² rigid core, or 0.5mm² - 2.5mm² stranded.

NOTE

Cable ferrules to DIN 46228 standard must be fitted to any stranded cable or screen wiring that is being used.

Ferrules for use with the field wiring terminals must be of length 10mm – 12mm. Figures 5.2 (a) & (b) illustrate the clamping mechanism and the need for a ferrule to reach the inner end of the terminal. If the wires are of a cross-sectional area of 2.2mm² or greater, a hexagon profile crimping tool should be used.

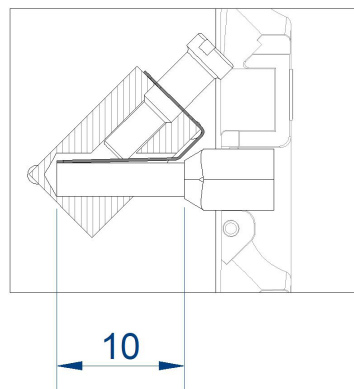

Figure 5.2(a) - Using 10mm ferrule

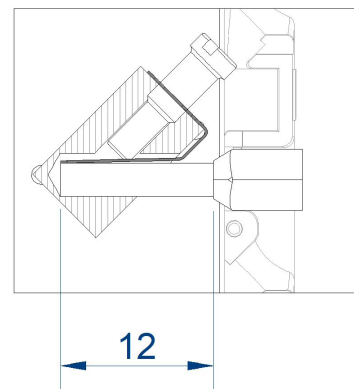

Figure 5.2(b) - Using 12mm ferrule

5.2.3 UI module installation

To mount a UI module, ensure that the orientation is as shown in Figure 5., and insert the bottom rear corner of the UI into the base module. Rotate it around this corner and push firmly until the connector engages, and the clip at the top of the UI should then click into place.



Figure 5.3 - Installing UI module

To remove a UI module, insert a flat-blade screwdriver of approximately 5mm (0.25inch) width into the position shown in Figure 5.4. Gently, but firmly, lever upwards to release the clip and pull down the top corner of the UI to remove it.

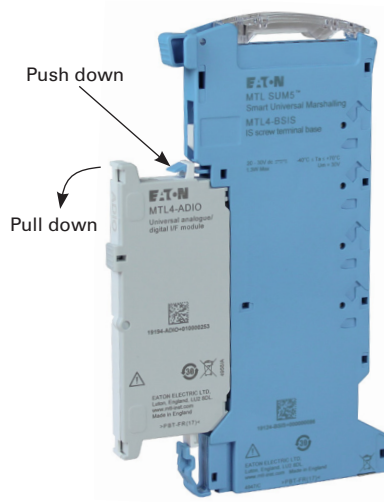

Figure 5.4 - Installing a module base

5.3 UI module LED indicators

Each UI module is fitted with two multi-colour LED indicators to allow the user to identify the operating mode and the status of the channel. They are marked with a letter 'M' for mode and 'S' for status. See Figure 5.5 for the location and identity of these indicators.

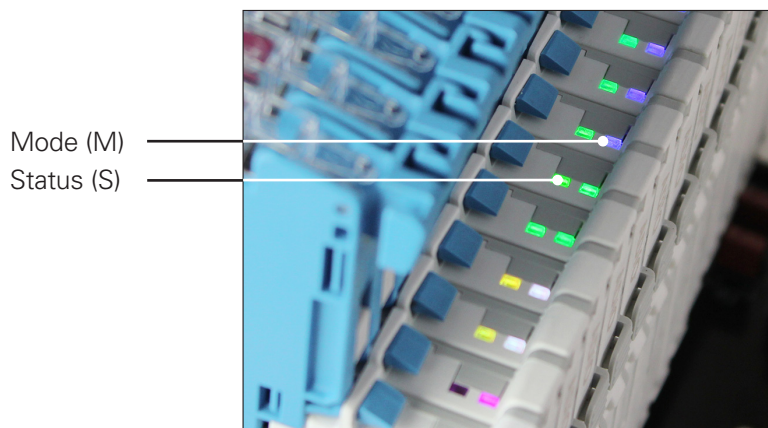

Figure 5.5 - LED indicators on UI module

5.3.1 Mode indicator (M)

The mode indicator uses different colours together with steady, blinking or flashing lights to display both the current mode of the isolator and its function. Use the following tables to interpret what is displayed. Use the following table to identify the basic mode.

Channel operation	Channel operation
Red – flashing	Not defined Config in base: No Config in UI: No
Red – single blink (On 3s, Off 100ms)	Not defined Config in base: No Config in UI: Yes
Green - steady	AO
Blue - steady	AI
Magenta - steady	DO
White - steady	DI

Use the following table to identify the type of activity/function.

UI function	Configuration	LED behaviour
Repeat mode	AI, AO, DI, DO	Colour for type
Trip mode	AI	Type colour + single blink
Frequency mode	DI	Type colour + single blink
1 in 2 out mode	Slave for any config.	Type colour + double blink

Single blink = On 3s, Off 100ms *Double blink = On 3s, Off 100ms, On 100ms, Off 100ms*

5.3.2 Status indicator (S)

The status indicator is used to identify operating states and any fault/error conditions. The table below gives a listing of the possible states and how the LED indicates that state.

Condition	Configuration	LED display
Low state	DI and DO	Off
High state	DI and DO	Yellow
OK	AI and AO	Green
Tripped	AI in Trip mode	Yellow
LFD state	All modes	Yellow flash
Module Fault	All modes	Red

5.4 Manual configuration with push button

Configuration is best carried out with the MTL4-PCS software configuration tool, but basic configuration, e.g. modes and mode changes can be carried out by using the configuration button on the front edge of the UI module.



Figure 5.6 - Manual configuration button

To configure a UI module, it must be installed in a module base, on a carrier, with the dc power connected. Press and hold the Configuration button (Figure 5.6) for 3 seconds until the Status (S) LED indicator starts to flash. Repeated clicks of the button will now cycle the modes in the order shown in the table below. When the list ends it loops round to the beginning again in a repeating cycle.

Flashing colour	Setting
Green	AO
Blue	AI
White	DI
Magenta	DO
Yellow	Copy config to base

When the required colour is displayed, stop pressing the button and the LED will stop flashing after a few seconds and remain steady at the colour chosen. A copy of the configuration is sent to the base module, so that if the UI module is removed and replaced by another, the same configuration will be passed to the UI on start-up.

5.5 Surge-protection module installation

In order to protect against induced voltage or current spikes carried on the field wiring, surge protection can be provided by a plug-in module (Part No. MTL4-SD or MTL4-SDR) that is installed on the top edge of the module base. (Note that there is no external physical difference between the two modules – check the module marking.)



Figure 5.7 - Surge-protection module fitting

Unclip and raise the tag strip holder to obtain access to the connector on the top of the module base. Check both connector pin interfaces to ensure the correct orientation then press the module pins into the base and push it until fully seated. The tag strip can then be folded down again until it clicks into place on the module. Removal of the module is simply the reverse of this procedure.

To enable this module to protect the equipment, a low impedance, surge ground connection **MUST** be installed from the carrier terminal (see Figure 4.4) to the plant ground. Use a wire gauge that offers at least 4mm² cross-sectional area for this connection. Check that each carrier that uses, or will use, surge protection is fitted with this connecting wire.

5.6 Ground module installation

The Ground module (Part No. MTL4-GND) is a plug-in module that can be installed on the top edge of the module base to provide a provisional ground connection for the field wiring terminals of that channel. This is a useful safety measure for field wiring that is installed, but not in current use.



Figure 5.8 - Ground module fitting

Unclip and raise the tag strip holder to obtain access to the connector on the top of the module base. Check both connector pin interfaces to ensure the correct orientation then press the module pins into the base and push it until fully seated. The tag strip can then be folded down again until it clicks into place on the module. Removal of the module is simply the reverse of this procedure.

5.7 Fitting Surge or Grounding module

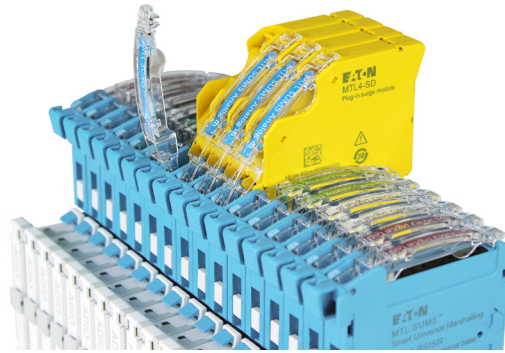

NOTE

The surge modules must be selected for use with the appropriate bases. The MTL4-SDR must be used with the MTL4-BSISR or MTL4-BSGPR as these have one pin connection blanked off to prevent the MTL4-SD module from being inserted

Base	Surge module
MTL4-BSIS	MTL4-SD
MTL4-BSISR	MTL4-SDR
MTL4-BSGP	MTL4-SD
MTL4-BSGPR	MTL4-SDR

5.8 Fitting MTL4-LNKIS link LK1

Link LK1 is fitted in IS applications when a suitably certified field device requires an increased power level from the IS interface. Typically used with solenoid valves and maybe 4-20mA transmitters, this link reduces the safety resistor to a lower ohmic value.



LK1 is positioned in the top of the MTL4-BSIS. Lift tag holder out of the way, as shown, and insert the link into the 2 socket holes provided. The link is visible to the user when installed.

6 UI CONFIGURATIONS AND CONNECTIONS

The MTL4-ADIO can be configured for input and output configuration to suit a wide range of signal types and ranges. It is the ideal complement for universal I/O system cards where the I/O is assigned on a channel by channel basis.

This section describes the key aspects of each possible UI configuration. The wiring connections are identified and any specific settings or parameters are itemised. The mode and its default configuration can be chosen manually by means of the configuration button, as described above, but other aspects of the channel configuration require the use of the system configuration software.

Detailed configuration is best carried out using the PC based, MTL4-PCS software configuration tool, but basic type functionality can be accomplished manually using the configuration button on the UI module. Once the configuration is established it can be stored in the module base. By this method, the UI module can be removed, swapped or substituted and the replacement UI will automatically adopt the configuration previously stored.

For a detailed technical specification, refer to the datasheet, which can be found on our website at <http://www.mtl-inst.com>

6.1 Digital input (DI)

The digital input configuration will respond to a range of 'switch-type' inputs connected as shown below. Phase reversal, when selected, inverts the phase of the system input signal.

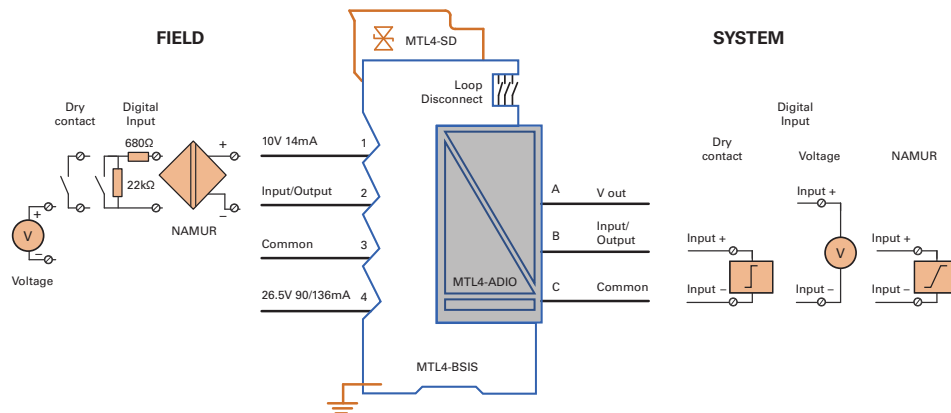

Figure 6.1 - Digital input options

The switch circuit is powered by the isolator and the signal transferred to the system as a change in resistance that will cause the current on the system input to vary. For switch 'open' the current will be 0mA, for switch 'closed' the current will be 10mA maximum, or less, depending on the system input type.

When using the LFD facility with a dry contact input, resistors must be used as shown in Figure 6.1.

Fit 500Ω to 1kΩ (preferred value 680Ω) in series with the switch and 20kΩ to 25kΩ (preferred value 22kΩ) in parallel with the switch.

6.2 Digital output (DO)

The DO mode enables an open-collector or contact switch output on the safe side to control an on/off device in the field.

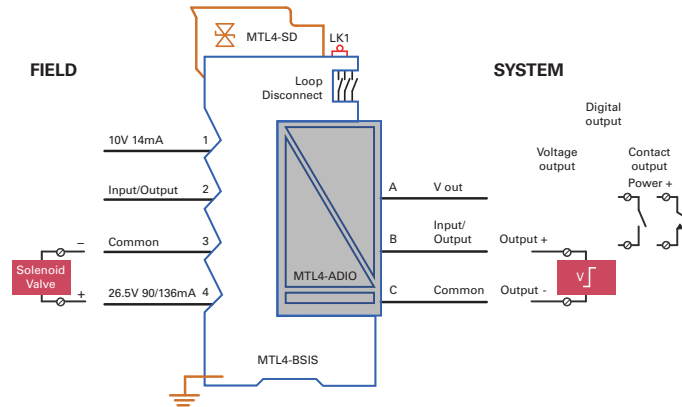

Figure 6.2 - Digital output options

The MTL4-BSIS module base can be fitted with a shorting link (LK1 – see diagram) to enable the user to increase the output current for solenoid drivers, if required. Consult the datasheet for the individual parameters.

MTL4-LNKIS-50	IS power jumper link (Pk50)
---------------	-----------------------------



WARNING!

Fitting link LK1 will change the Safety Description of the product. Refer to the certificate for details.

Note: LFD, when configured, is provided by detecting the field conditions using a 24V 1mS pulse every 1 second. Some LED and sounders may respond to this pulse when enabled.

6.3 Digital output (DO - with switched contacts)

This configuration is an option when relay contacts are required to drive a digital load in the field. Choose one of the Relay module bases from the table below to suit the field wiring.

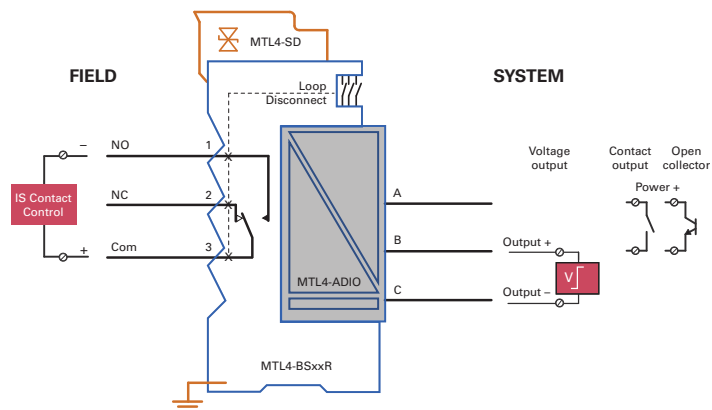

Figure 6.3 - Digital output with relay options

MTL4-BSGPR	Module base general-purpose relay
MTL4-BSISR	Module base IS relay

The user can choose from normally open (NO) or normally closed (NC) contacts to suit the application. Inductive loads should be provided with suitable suppression circuitry to avoid damaging voltage spikes.

Consult the product datasheet for applicable drive voltages and relay contact ratings.

6.4 Analogue input (AI)

The MTL4-ADIO provides a fully floating dc supply for conventional 2 or 3-wire 4/20mA transmitters. In addition, HART transmitters are supported, offering bi-directional communications signals superimposed on the 4/20mA loop current. A link (LK1) can be fitted to the module base to increase the transmitter voltage for non-HART applications, when necessary. Consult the datasheet for full details.

MTL4-LNKIS-50	IS power jumper link (Pk50)
---------------	-----------------------------

WARNING!

Fitting link LK1 will change the Safety Description of the product. Refer to the certificate for details.

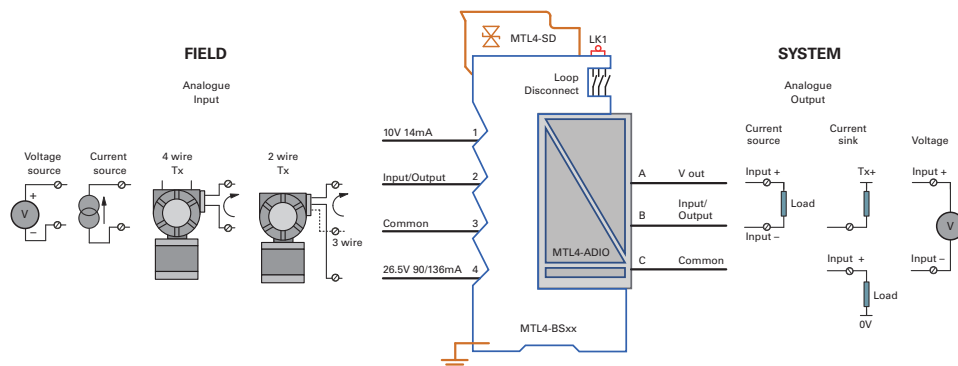

Figure 6.4 - Analogue input options

There is provision for a selection of sink or source current outputs on the system side, as illustrated above, as well as a voltage option.

6.5 Analogue output (AO)

Terminals B+ and C- are used to accept the 4-20mA signal from the control system. The current is repeated into the hazardous area through terminals 4+ and 2-.

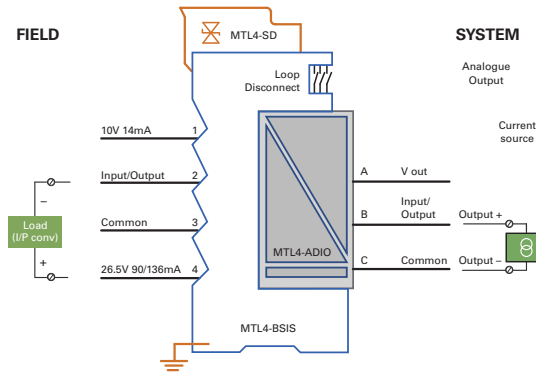

Figure 6.5 - Analogue output options

6.6 Bypass module

The MTL4-BYP module can provide a pass-through function in the same body package as the MTL4-ADIO. When necessary, this is able to provide direct 'through' wiring in the manner shown in the table below.

Field wiring	To	Control wiring
1 & 4	—	A
2	—	B
3	—	C

The MTL4-BYP Bypass module may be used ONLY with General Purpose bases (MTL4-BSGP or MTL4-BSGPR). A key is built-in to the connector to prevent its insertion into an IS base.

6.7 Alarm module(s)

One or more Alarm modules, when used, are fitted on the end of the carrier and use a keyway on the connector to ensure that they are oriented correctly. Fit the Alarm module and then secure it with the two captive screws at each end of its base.

A pair of screw clamp terminals is provided on the carrier for each Alarm module to provide access to the isolated switch contacts inside the module. They are not polarity sensitive and are normally open.

The screw clamp terminals will accommodate wire cross-sectional areas from 0.5mm² - 4 mm² rigid core, or 0.5mm² - 2.5mm² stranded.

NOTE

Cable ferrules to DIN 46228 standard must be fitted to any stranded cable or screen wiring that is being used.

Ferrules of length 6mm are recommended for use on the alarm terminal blocks.

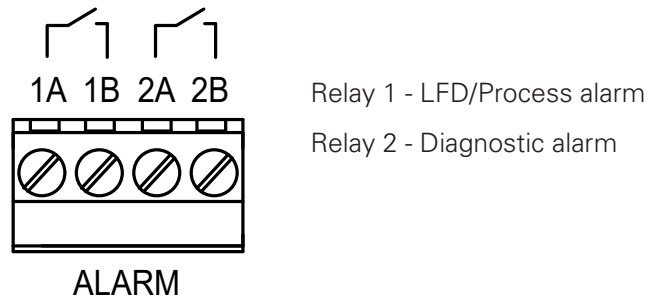

Figure 6.6 - Alarm module connections

LFD/Process alarm

This relay contact provides a common alarm for any LFD or Process alarms that are re-configured in any of the 16 channels.

Diagnostic alarm

This relay contact provides a common alarm to report Universal Module failures or fault conditions.

6.8 Loop disconnect



Figure 6.7 - Loop Disconnect

Use screwdriver, as shown, to break connection between universal isolator and field terminals. If the surge module is fitted this will still be connected to the field and will need to be removed if field wire testing is to be carried out. To reconnect loop, press clip back into terminal base.

7 FAULT FINDING AND ROUTINE MAINTENANCE

7.1 Fault finding

When fault finding, carry out the following steps as far as is necessary.

- Check that, at least, one of the carrier power LEDs is ON.
- If a power LED is not on, first check the incoming supply is present and then check the on-board 2.5A (T) fuse(s) and replace blown ones, after identifying the cause of the fuse rupture. (Spare fuse kit FUS2.5ATE5 Pk 10)
- Check that all UI modules are displaying a green Status LED.
- A flashing LED indicates alarm or fault conditions - refer to section 8. Note: The LED may also flash during intermediate stages of configuration.
- Exchange a potentially faulty UI module for a working unit (see Section 5.2.2 for method).

Note that a replacement UI will automatically acquire the configuration from the module base.



WARNING!

MTL4 range products **MUST NOT** be repaired. Faulty or damaged products must be replaced with an equivalent certified product.

7.2 Routine maintenance

Check the general condition of the installation occasionally to make sure that no deterioration has occurred. Carry out the following at least once every two years and more frequently for particularly harsh environments.

- a) Check the module LEDs to ensure that no ERROR conditions are being indicated..
- b) Check to see that all UI modules do not appear to have been disturbed and appear to be seated correctly in their module bases.
- c) Check to see that any surge suppression modules fitted are correctly seated and the tag strips are locked in place.
- d) Check that modules and hazardous-area connections are correctly and legibly tagged, and that the tag details given comply with the relevant documentation.

8 APPENDIX A

The following information is taken from the sgs baseefa limited examination certificate. For full details refer to certificate number Baseefa19ATEX0022X on the Eaton-MTL website <http://www.mtl-inst.com>

8.1 I/O Parameters – MTL4-BSIS IS Module Base & MTL4-ADIO Interface Module

Non-Hazardous Area Connector CON1, Pins 1 to 6 & 9 to 12

$$U_m = 30V$$

The non-hazardous Connector CON1, pins 1 to 6, & 9 to 12 are designed to operate from a d.c. supply voltage of up to 30V supplied from either safety extra low-voltage (SELV) or protective extra low-voltage circuits, for example equipment complying with the requirements of either the IEC 60950 series, IEC 61010-1 or a technically equivalent standard.

Digital O/P Configuration - Hazardous Area Terminals 4 w.r.t. 3 (IS Power Jumper Link not Fitted)

$$\begin{aligned} U_o &= 26.5V & V & \quad C_i = 0 \\ I_o &= 90mA & & \quad L_i = 0 \\ P_o &= 0.6W \end{aligned}$$

Digital O/P Configuration - Hazardous Area Terminals 4 w.r.t. 3 (IS Power Jumper Link Fitted)

$$\begin{aligned} U_o &= 26.5V & C_i &= 0 \\ I_o &= 136mA & L_i &= 0 \\ P_o &= 0.9W \end{aligned}$$

Analogue O/P Configuration – Hazardous Area Terminals 4 w.r.t. 2 (IS Power Jumper Link not Fitted)

$$\begin{aligned} U_o &= 26.5V & C_i &= 0.5nF \\ I_o &= 90mA & L_i &= 0 \\ P_o &= 0.6W \end{aligned}$$

Analogue O/P Configuration – Hazardous Area Terminals 4 w.r.t. 2 (IS Power Jumper Link Fitted)

$$\begin{aligned} U_o &= 26.5V & C_i &= 0.5nF \\ I_o &= 136mA & L_i &= 0 \\ P_o &= 0.9W \end{aligned}$$

Digital I/P Configuration – Hazardous Area Terminals 2 w.r.t. 3

$$\begin{aligned} U_o &= 10V & C_i &= 0.5nF \\ I_o &= 0.13mA & L_i &= 0 \\ P_o &= <1mW \end{aligned}$$

The hazardous area terminals 2 w.r.t. 3 are also considered suitable for the connection of an external intrinsically safe source with a $U_o = 30V$ and $I_o = 100mA$. When an intrinsically safe source is connected to these terminals the capacitance and either the inductance or inductance to resistance ratio (L/R) of the hazardous area connections must not exceed the values detailed in the certificate of the intrinsically safe source.

Hazardous area terminals 1 & 4 must not be used when a source is connected to these terminals.

Digital I/P Configuration – Hazardous Area Terminals 1 w.r.t. 2

$U_o = 10V$ $C_i = 0.5nF$
 $I_o = 14mA$ $L_i = 0$
 $P_o = 35mW$

Analogue I/P Configuration – Hazardous Area Terminals 2 w.r.t. 3

$U_o = 10V$ $C_i = 0.5nF$
 $I_o = 0.13mA$ $L_i = 0$
 $P_o = <1mW$

The hazardous area terminals 2 w.r.t. 3 are also considered suitable for the connection of an external intrinsically safe source with a $U_o = 30V$ and $I_o = 100mA$. When an intrinsically safe source is connected to these terminals the capacitance and either the inductance or inductance to resistance ratio (L/R) of the hazardous area connections must not exceed the values detailed in the certificate of the intrinsically safe source.

Hazardous area terminals 1 & 4 must not be used when a source is connected to these terminals.

**Analogue I/P Configuration – Hazardous Area Terminals 4 w.r.t 2
(IS Power Jumper Link not Fitted)**

$U_o = 26.5V$ $C_i = 0.5nF$
 $I_o = 90mA$ $L_i = 0$
 $P_o = 0.6W$

**Analogue I/P Configuration – Hazardous Area Terminals 4 w.r.t 2
(IS Power Jumper Link Fitted)**

$U_o = 26.5V$ $C_i = 0.5nF$
 $I_o = 136mA$ $L_i = 0$
 $P_o = 0.9W$

**Analogue I/P Configuration – Hazardous Area Terminals 2 & 4 w.r.t 3
(IS Power Jumper Link not Fitted)**

$U_o = 26.5V$ $C_i = 0.5nF$
 $I_o = 90mA$ $L_i = 0$
 $P_o = 0.6W$

**Analogue I/P Configuration – Hazardous Area Terminals 2 & 4 w.r.t 3
(IS Power Jumper Link Fitted)**

$U_o = 26.5V$ $C_i = 0.5nF$
 $I_o = 136mA$ $L_i = 0$
 $P_o = 0.9W$

8.2 Load Parameters

The capacitance and either the inductance or the inductance to resistance ratio (L/R) of the hazardous area load connected must not exceed the following values:

GROUP	CAPACITANCE (μF)	INDUCTANCE (mH)	L/R RATIO ($\mu\text{H}/\text{ohm}$)
Hazardous Area Terminals 4 w.r.t. 3 (IS Power Jumper Link not Fitted)			
IIC	0.095	4.29	58
IIB*	0.73	17.1	235
IIA	2.45	34.3	471
I	4.3	56.3	774
Hazardous Area Terminals 4 w.r.t. 3 (IS Power Jumper Link Fitted)			
IIC	0.095	2.00	39
IIB*	0.73	8.40	157
IIA	2.45	16.4	315
I	4.3	56.3	517
Hazardous Area Terminals 4 w.r.t. 2 (IS Power Jumper Link not Fitted)			
IIC	0.095	4.29	58
IIB*	0.73	17.1	235
IIA	2.45	34.3	471
I	4.3	56.3	774
Hazardous Area Terminals 4 w.r.t. 2 (IS Power Jumper Link Fitted)			
IIC	0.095	2.00	39
IIB*	0.73	8.40	157
IIA	2.45	16.4	315
I	4.3	56.3	517
Hazardous Area Terminals 2 w.r.t. 3			
IIC	3.0	1000	109,401
IIB*	20.0	1000	437,606
IIA	100	1000	875,213
I	180	1000	1,435,897
Hazardous Area Terminals 1 w.r.t. 2			
IIC	3.0	172.4	1,015
IIB*	20.0	656.4	4,063
IIA	100	1000	8,126
I	180	1000	13,333
Hazardous Area Terminals 2 w.r.t. 3 (IS Power Jumper Link not Fitted)			
IIC	0.095	4.29	58
IIB*	0.73	17.1	235
IIA	2.45	34.3	471
I	4.3	56.3	774
Hazardous Area Terminals 2 & 4 w.r.t. 3 (IS Power Jumper Link Fitted)			
IIC	0.095	2.00	39
IIB*	0.73	8.40	157
IIA	2.45	16.4	315
I	4.3	56.3	517

* Group IIB parameters also applicable for associated apparatus [Ex ia Da] IIIC

Notes:

- The above load parameters apply when one of the two conditions below is given:
 - the total L_i of the external circuit (excluding the cable) is $< 1\%$ of the L_o value or
 - the total C_i of the external circuit (excluding the cable) is $< 1\%$ of the C_o value.
- The above parameters are reduced to 50% when both of the two conditions below are given:
 - the total L_i of the external circuit (excluding the cable) is $\geq 1\%$ of the L_o value and
 - the total C_i of the external circuit (excluding the cable) is $\geq 1\%$ of the C_o value.

The reduced capacitance of the external circuit (including cable) shall not be greater than $1\mu\text{F}$ for Groups IIB, IIA & I and 600nF for Group IIC.

The values of L_o and C_o determined by this method shall not be exceeded by the sum of all of the L_i plus cable inductances in the circuit and the sum of all of the C_i plus cable capacitances respectively.

9 APPENDIX B

9.1 Fault finding

Power Supply rating:

– 20 to 30Vdc, max 100mA per channel (mode dependent)

Power supply terminals:

– 0.5 to 2.5mm² stranded wire, 0.5-4mm² solid. Ferrule length 10mm

Field terminal rating:

– 24V/50mA maximum

Field terminals:

– 0.5 to 2.5mm² stranded wire, 0.5-4mm² solid. Ferrule length 10-12mm

Ingress Protection rating:

– IP20

10 APPENDIX C

10.1 Ordering information

Interface modules	
MTL4-ADIO	Universal analogue/digital interface
MTL4-ADIO-50	Universal analogue/digital interface (Pk 50)
MTL4-BYP*	Bypass module
MTL4-BYP-50*	Bypass module (Pk 50)
MTL4-TI*	Temperature converter
MTL4-TI-50*	Temperature converter (Pk 50)

Carriers with bases	
MTL4-CS16IS	16ch universal IS carrier, screw terminals, 16 x MTL4-BSIS fitted
MTL4-CS16GP	16ch universal GP carrier, screw terminals, 16 x MTL4-BSGP fitted

Carrier only	
MTL4-CS16	16ch carrier, no module bases fitted, screw terminals

Terminal bases	
MTL4-BSIS	Terminal base IS
MTL4-BSISR*	Terminal base IS relay
MTL4-BSGP	Terminal base GP
MTL4-BSGPR*	Terminal base GP relay

Surge modules	
MTL4-SD	Plug-in surge module
MTL4-SDR*	Plug-in surge for relay module
MTL4-SDT*	Plug in surge for temperature inputs

Spares & Accessories	
MTL4-GND	Grounding module
MTL4-LNKIS-50	IS power jumper link (Pk50)
MTL4-TH-50	Spare UI tag holders (Pk50)
MTL4-ICC-50*	Isolator Connector cover, for spare module bases (Pk50)
MTL4-PCS	Configuration software
MTL4-PCL	Configuration adaptor link
MTL4-SMK-10	Carrier surface mounting kit (Pk 10 pairs)
FUS2.5ATE5	2.5A (T) replacement fuses (Pk 10)

*check availability

EATON Crouse-Hinds series

The safety you rely on.

See the complete MTL product portfolio at www.mtl-inst.com

For more information:

If further assistance is required, please contact an authorised MTL Distributor, Sales Office, or Customer Service Department

AUSTRALIA

Eaton Electrical (Australia) Pty Ltd,
10 Kent Road, Mascot, New South Wales, 2020, Australia
Tel: +61 1300 308 374 Fax: +61 1300 308 463
E-mail: mtlsalesanz@eaton.com

BeNeLux

MTL Instruments BV
Ambacht 6, 5301 KW Zaltbommel
The Netherlands
Tel: +31 (0)418 570290 Fax: +31 (0)418 541044
E-mail: mtl.benelux@eaton.com

CHINA

Cooper Electric (Shanghai) Co. Ltd
955 Shengli Road, Heqing Industrial Park
Pudong New Area, Shanghai 201201
Tel: +86 21 2899 3817 Fax: +86 21 2899 3992
E-mail: mtl-cn@eaton.com

FRANCE

MTL Instruments sarl,
7 rue des Rosiéristes, 69410 Champagne au Mont d'Or
France
Tel: +33 (0)4 37 46 16 53 Fax: +33 (0)4 37 46 17 20
E-mail: mtlfrance@eaton.com

GERMANY

MTL Instruments GmbH,
Heinrich-Hertz-Str. 12, 50170 Kerpen, Germany
Tel: +49 (0)22 73 98 12- 0 Fax: +49 (0)22 73 98 12- 2 00
E-mail: csckerpen@eaton.com

INDIA

MTL India,
No.36, Nehru Street, Off Old Mahabalipuram Road
Sholinganallur, Chennai- 600 119, India
Tel: +91 (0) 44 24501660 /24501857 Fax: +91 (0) 44 24501463
E-mail: mtlindiasales@eaton.com

ITALY

MTL Italia srl,
Via San Bovio, 3, 20090 Segrate, Milano, Italy
Tel: +39 02 959501 Fax: +39 02 95950759
E-mail: chmninfo@eaton.com

JAPAN

Cooper Crouse-Hinds Japan KK,
MT Building 3F, 2-7-5 Shiba Daimon, Minato-ku,
Tokyo, Japan 105-0012
Tel: +81 (0)3 6430 3128 Fax: +81 (0)3 6430 3129
E-mail: mtl-jp@eaton.com

NORWAY

Norex AS
Fekjan 7c, Postboks 147,
N-1378 Nesbru, Norway
Tel: +47 66 77 43 80 Fax: +47 66 84 55 33
E-mail: info@norex.no

RUSSIA

Cooper Industries Russia LLC
Elektrozavodskaya Str 33
Building 4
Moscow 107076, Russia
Tel: +7 (495) 981 3770 Fax: +7 (495) 981 3771
E-mail: mtlruussia@eaton.com

SINGAPORE

Eaton Electric (Singapore) Pte Ltd
100G Pasir Panjang Road
Interlocal Centre
#07-08 Singapore 118523
#02-09 to #02-12 (Warehouse and Workshop)
Tel: +65 6 645 9888 ext 9864/9865
Fax: +65 6 645 9811
E-mail: sales.mtling@eaton.com

SOUTH KOREA

Cooper Crouse-Hinds Korea
7F Parkland Building 237-11 Nonhyun-dong Gangnam-gu,
Seoul 135-546, South Korea.
Tel: +82 6380 4805 Fax: +82 6380 4839
E-mail: mtl-korea@eaton.com

UNITED ARAB EMIRATES

Cooper Industries/Eaton Corporation
Office 205/206, 2nd Floor SJ Towers, off. Old Airport Road,
Abu Dhabi, United Arab Emirates
Tel: +971 2 44 66 840 Fax: +971 2 44 66 841
E-mail: mtlgulf@eaton.com

UNITED KINGDOM

Eaton Electric Ltd,
Great Marlings, Butterfield, Luton
Beds LU2 8DL
Tel: +44 (0)1582 723633 Fax: +44 (0)1582 422283
E-mail: mtlenquiry@eaton.com

AMERICAS

Cooper Crouse-Hinds MTL Inc.
3413 N. Sam Houston Parkway W.
Suite 200, Houston TX 77086, USA
Tel: +1 281-571-8065 Fax: +1 281-571-8069
E-mail: mtl-us-info@eaton.com